

## SIMPLE TROUBLE SHOOTING

### PROBLEMS, CAUSES & SOLUTIONS

#### No power

- Check and make sure the connecting wires are connected correctly
- Check whether the fuse is blown. Replace with the proper value fuse if necessary.

#### No sound

- Check and make sure the speaker wires are connected correctly.

#### No picture

- Check whether the video wire is connected to the video device.

#### Unit hang-up

- Press the RESET button to reset the unit to its default stage.

#### No function when pressing the buttons or TFT screen

- Press the RESET button to reset the unit to its default stage.

#### Poor effect or unable to receive radio

- Check whether the radio antenna is inserted or properly connected.
- Antenna may not be the proper length. Make sure the antenna is fully extended.
- Antenna may be poorly grounded. Check and make sure the antenna is properly grounded.

#### Stereo cannot be received under radio mode

- Tune the radio frequency accurately.
- The broadcasting signal is too weak, set the mode to MONO.

#### Disc inserted but cannot play

- Check whether the disc inserted upside down.
- Check whether the disc is dirty or badly cracked.
- Lens is dirty. Clean lens by using the lens clean disc.

#### Picture without colour or no sound under disc

- Improper setting of colour system. Set again to "PAL", "SECAM" or "NTSC".
- The disc is dirty or damaged. Wipe the disc with a dry soft cloth or replace a new disc.

#### Abnormal moving, skipping or sound during playback

- The disc is dirty or damaged. Wipe the disc with a dry soft cloth or replace with a new disc.

#### Remote handset does not work

- Replace new battery of the remote handset.
- Point the remote handset directly at the remote sensor of the main unit.
- Clean the surface of the remote sensor.

#### Bluetooth not operated

- check the devices are linked up correctly.

#### Note

After the above efforts, if the unit still cannot be worked normally, consult your service dealer. Never attempt to disassemble the unit by yourself. No service part inside the unit.

# POWER ACOUSTIK

## PDN-1060HB

2Din 10.6" Monitor

Touch Screen

DVD/CD/MP3/MP4

AM/FM Radio

With Android Phone Link

With Bluetooth

With GPS



## Owner's Manual

Take the time to read through this owner's manual. Familiarity with installation and operation procedures will help you obtain the best Performance from your new DVD-receiver.

### Floating dock operation under mobile phone linking:

- 1. During mobile phone linking and when this floating dock icon appeared on screen, touch to activate **FLOATING DOCK MENU** on screen for various functions and controls of the unit. This menu will be closed when no operation for a while. Touch any blank portion on screen will also close this menu.

#### FLOATING DOCK MENU

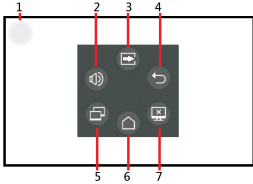

1. Touch to activate **FLOATING DOCK MENU** on screen for various functions and controls of the unit. Hold & slide can move this icon to other desired position on the screen.
2. Touch to activate audio & visual setting for various audio & visual setup (refer to ON SCREEN – AUDIO & VISUAL SETTING for details) of the car unit.
3. Touch to shift screen to the **MAIN MENU** of the car unit.
4. Touch to shift screen to previous page of the connected phone.
5. Touch to shift horizontal / vertical viewing of the connected phone.
6. Touch to shift screen to the main menu of the connected phone.
7. Touch to turn off the screen. When the screen turned off, touch any portion of the screen to turn on the screen.

### ON SCREEN – MOBILE PHONE LINK OPERATION



At MAIN MENU, touch on screen to start mobile phone linking of the connected mobile phone operation. (Note: Mobile phone must be connected to the front USB of the unit)

For Android devices, when the phone is connected at the first time, **SETUP MENU** appeared on screen.



1. Scan the QR code by using the connected android phone. Follow the instruction of the connected phone & download "AUTOLINK" application from Google Play Store or Amazon site. Open "AUTOLINK" application after download, mirror linking appeared on screen and mobile phone operation can be started and controlled by touching screen of the unit.
2. Touch to connect with the mobile phone.
3. Touch to shift to **USB DEBUG MENU** and follow the information to have USB debug on the mobile phone before connecting again.
4. Touch to return to **SETUP MENU**.
5. Touch to exit mobile phone linking operation and shift to previous operation mode.
6. Touch to shift to **MAIN MENU** for various operation and setup.
7. Touch to shift to Bluetooth mode for operation (available when a mobile phone connected).
8. Touch to activate audio & visual setting for various audio & visual setup (refer to ON SCREEN – AUDIO & VISUAL SETTING for details).
9. Touch to turn off the screen. When the screen turned off, touch any portion of the screen to turn on the screen.

#### Important notice on mobile phone linking operation on Android devices:

1. This head unit supports Android phone up to version 6.0 with USB mirror linking function only.
2. USB cable should be used to connect the phone to the front USB slot of the head unit.
3. In case connecting failed, **CONNECT FAILURE MENU** appeared on screen. Refer to its detail and **USB DEBUG MENU**, follow the step in order to have set up of the phone (USB debug).
4. Phone set up will be varied from different phones. Refer to the operation method of the phone for detail (usually at setting mode → developer options → USB debugging).
5. Depends on the connected smart phone, operation & setting may be varied.

## SPECIFICATION

### GENERAL

Power Requirement:	DC 12 Volts, negative ground
Load Impedance:	4 Ohms
Maximum Power Output:	40 watts x 4 (RMS)
Tone Control -Bass (at 100 Hz)	+/- 8 dB
Treble (at 10 KHz)	+/- 8 dB

### AM RADIO SECTION

Frequency Range	522 -1620 KHz ( Europe )
	530 -1710 KHz ( America )
Usable Sensitivity (-20 dB)	25 dB

### FM RADIO SECTION

Frequency Range	87.5 -108 MHz ( Europe )
	87.5 -107.9 MHz ( America )
Usable Sensitivity (-20 dB)	15 dB
Signal to Noise Ratio	60 dB
Stereo Separation (at 1 KHz)	30 dB
Frequency Response	30 Hz -15 KHz

### DISC SECTION

Disc Play:	DVD / VCD / MP3/ CD
Mounting Angle:	+/- 30 degree

### VIDEO SECTION

Video System:	NTSC / SECAM / PAL
Video Output Level:	1.0Vp-p 75 Ohms
Horizontal Resolution:	500

### BLUETOOTH SECTION

Communication type:	V4.0
Maximum Distance:	5 meters

### PREOUT SECTION

Maximum Output Level:	2 Vrms (+/-3 dB)
Frequency Response:	20 Hz to 20 KHz
Signal to Noise Ratio:	85 dB
Channel Separation:	80 dB

Note: Specification and design; functions and features; unit illumination; colour and display segment are subject to change without prior notice. Photos and drawings on gift box or operation manual might be varied from the exact unit. Depends on the input devices, operation might be varied from the operation manual described.

## IMPORTANT NOTICE & PRECAUTIONS

Thank you for using our company multi-media player! To operate the unit correctly, please read the operation manual carefully before using. Keep this operation manual for further reference.

The unit is designed only for DC 12V negative ground operation system. Make sure your vehicle is connected to DC 12V negative ground operation system. Be sure to connect the speaker(-) leads to the speaker(-) terminal. Never connect the left and right channel speaker wires together or to the vehicle body.

The normal temperature for operation is between -20 and +60 degree Celsius. Do not work in extreme high or low temperature and lock vents or radiator panels of the unit, blocking them will cause heat to build up inside the unit and may cause damage or fire.

This unit can play the following discs (12 cm) and media files: DVD±R/RW / MPEG 4 / DivX / AVI / SVCD / VCD / MP3 / WMA / CD-R/RW / JPEG.

## INSTALLATION

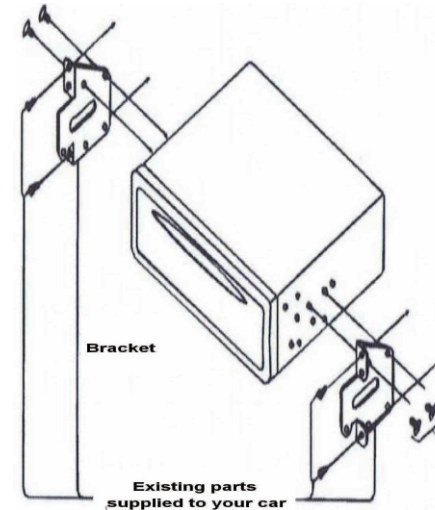

### Notes:

- Installation varies on type of cars and supplied parts
- Store small articles in places not accessible to children
- Install only with the supplied screws
- Installation of unit by professional technician is strongly recommended

### Remarks:

Mounting brackets and screws are the parts that supplied in your car and not provided in this unit.

## WIRING CONNECTION

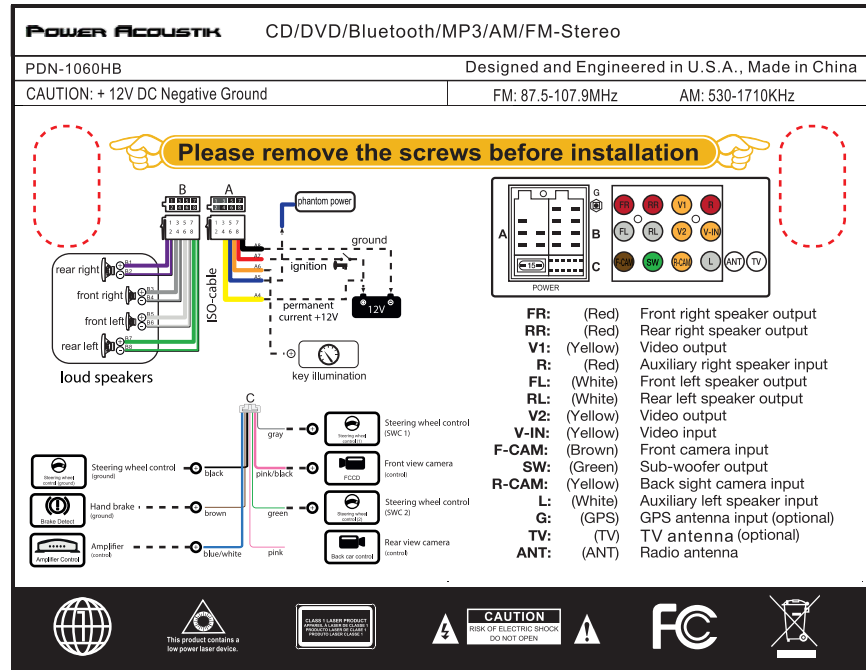

## APPLICATION TO CONTROL THE UNIT VIA BLUETOOTH OF MOBILE PHONE

(Andorid support only)

User can download the following application to the mobile phone in order to have control of the main unit by the mobile phone via Bluetooth. Take your phone and follow the steps:

~ for Android device, search "iCon" from Google Store and after searched, download & install:



~ After installation, open application:



~ The following menu appeared in the mobile phone and you can start control the car unit with this menu (Bluetooth must be connected):



~ The following shows the control option:



1. Radio band selection
2. Adjust the volume up or down
3. Adjust the EQ selections
4. Selection of operation mode
5. Mute function
6. Upward operation
7. Playback/pause control
8. Downward operation
9. Back to homepage
10. Setting

Remarks: The operation under this application is limited to some modes & controls only.

11. Touch to shift conversation between mobile phone & Bluetooth of the unit.
12. Touch to dial out after input the phone number or redial when no phone number input.
13. Touch to hang up or refuse an incoming call.
14. Touch to erase the digit input by error.
15. Touch directly to input the phone number.
16. Touch to start downloading the outgoing call from the linked mobile phone.  
Touch anyone of the contact for dial out.
17. Touch to start downloading the incoming call from the linked mobile phone.  
Touch anyone of the contact for dial out.
18. Touch to start downloading the missing call from the linked mobile phone.  
Touch anyone of the contact for dial out.
19. Touch to shift page up or down.
20. Touch to activate **BT PHONEBOOK SEARCH MENU** for searching contact details on phonebook.
21. Touch repeatedly to select upward or downward track for playback.
22. Touch to start / pause / resume music playback transmitted from the mobile phone.

## ON SCREEN – AUXILIARY INPUT OPERATION







At **MAIN MENU**, touch to shift to auxiliary input operation (provided an auxiliary video device had been connected). At auxiliary input operation, touch any portion of screen to activate **AV INPUT MENU** for operation.

### **AV INPUT MENU**



1. Touch to turn off the screen. When the screen turned off, touch any portion of the screen to turn on the screen.
2. Touch to activate audio & visual setting for various audio & visual setup (refer to ON SCREEN – AUDIO & VISUAL SETTING for details).
3. Touch to shift to Bluetooth mode for operation (available when a mobile one connected).
4. Touch to shift screen to **MAIN MENU**.

<u>Symbol / Function</u>	<u>Operation &amp; Controls</u>
/ SRC /	<u>Power On/Off</u> When the unit is turned off, press to turn on the unit. When the unit is turned on, press & hold shortly to turn off the unit.
SRC	Press repeatedly to select the desired mode for operation. Note: GPS mode cannot be selected by this control key <u>Bluetooth Mode (when a mobile phone connected)</u> Press to hang up or refuse an incoming call.
IR	Remote control sensor (for signal reception from remote handset)
LCD DISPLAY	It shows the status of current operation of the unit.
FUNCTION CONTROL	<u>Volume Control</u> Rotate to adjust sound output level. Press to turn on or off of sound muting control.
USB	Insert USB device to this slot for digital files playback. Important: The USB port is intended only for data transfer only, other devices cannot be used with this USB connection. The use of USB extension cords is not recommended.
SD or	Insert SD / MMC card to this port for digital files playback.
AUX	Insert an external device to this jack in order to have output of the external device through the unit.
DISC SLOT	Insert or remove disc from this disc slot.
or EJ	<u>Disc Input Mode</u> Press to eject disc from the disc slot. <u>Bluetooth Mode</u> Press & hold shortly to disconnect the link-up with mobile phone (when a mobile phone has been connected with Bluetooth of the unit).
BND or BAND /	<u>Radio Mode</u> Press repeatedly to select the desired radio band for broadcasting. <u>Disc / USB / SD Input Mode</u> Press repeatedly to select video system in PAL / NTSC / AUTO mode. <u>Bluetooth Mode (when a mobile phone connected)</u> When an incoming call received, press to pick up the call. Press to dial out after input a phone number. Press to redial the last dial out number.
/	<u>Radio Mode – Auto Seek</u> Press to start automatic seeking frequency upward or downward to the next strong station received for broadcasting. <u>Radio Mode – Manual Tune</u> Press & hold shortly to activate manual tuning mode. At this mode, press repeatedly to tune the radio frequency upward or downward.
/	<u>Disc / USB / SD / Input Mode – Select Tracks</u> Press repeatedly to shift track upward or downward for playback. <u>Disc / USB / SD / Input Mode – Track Fast Forward / Fast Rewind</u> Each time press & hold shortly to activate various fast forward/rewind speeds for playback. <u>Bluetooth Music Playback Mode – Select Tracks</u> Press repeatedly to shift track upward or downward for playback.

RESET	Press with a pointed object (such as a ball point) to reset the unit to its initial setting by the factory (default stage).
PRESET MEMORY STATION NO 1 – 6	At radio mode, press any one of the preset number to select a station that had been stored in the memory for broadcasting. Press and hold shortly of any one of the preset number can store the current broadcasting station in the memory.
PAU or 	At disc / USB / SD input mode & Bluetooth music playback mode, press to start or pause playback.
INT	At disc / USB / SD input mode, press to start intro playback of each track for 10 seconds. Press again to resume to normal playback mode.
RPT	At disc / USB / SD input mode, press to select various repeat playback mode (track/chapter/title) of the device.
RDM	At disc / USB / SD input mode, press to start random playback of the device. Press again resume to normal playback mode.
5	At disc / USB / SD input mode, press repeatedly to select video system in PAL / NTSC / AUTO mode.
6	At disc / USB / SD input mode, press repeatedly to select audio output channels that recorded in the device.
MIC	This is the microphone for voice reception at Bluetooth call.
OPEN	Press to flip up or store back the TFT screen from the compartment.
	When the TFT screen has been flipped up, press repeatedly to adjust the angle for viewing. Press and hold  shortly to store back the TFT screen to its compartment. When the TFT screen has been stored in its compartment, press  to pop up the TFT screen.
	Press to detach the front panel from the main unit for security purpose. When the front panel has been detached, insert micro SD card to SD slot as well as micro SD card to GPS slot for media files playback & GPS navigation respectively.
REL	
OSC	In video & photo playback mode, press & hold shortly to display the contents of the currently playin sources on screens.(Note:Depends on the media files recorded,not all sources can be display)
MENU	<u>For unit without GPS navigation</u> press & hold shortly to shift the current operating mode to the main menu for operation options. <u>for unit with GPS navigation</u> press & hold shortly to shift the current operating mode to GPS navigation mode or from the GPS navigation mode to the previous operating mode.

**Note**  
Printings and symbols on the above may be varied from the exact main unit. Referred to the main unit for exact functions and features that applied. User is highly recommended to use the touch screen control to operate. Most of the operations of this unit cannot be controlled by the main unit.

## ON SCREEN – BLUETOOTH OPERATION

During unit operation, touch 「Bluetooth」 icon on screen to shift to Bluetooth operation.

### LINK UP WITH MOBILE PHONE

- To linkup Bluetooth connection with the mobile phone,take your phone and follow the steps:
- set the mobile phone to Bluetooth state
  - start to search new device
  - after searched, new device( CAR KIT /CAR BT or similar) searched out, confirm the search
  - in case of need, input default code "0000" or "8888" in the mobile phone
  - once connected, BT icon appeared on screen & "Connected" appeared on **BT PHONE MENU**.
- connection succeeded and you can start using Bluetooth function

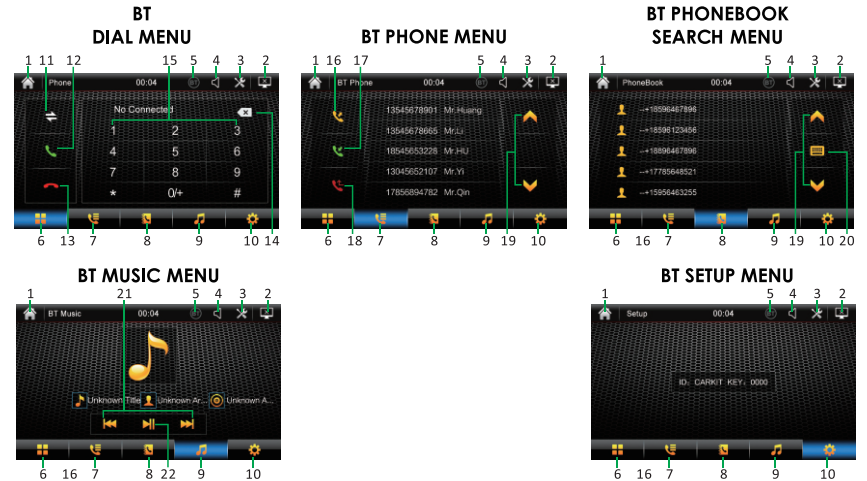

1. Touch to shift screen to **MAIN MENU** for various operation and setup.
2. Touch to turn off the screen. When the screen turned off, touch any portion of the screen to turn on the screen again.
3. Touch repeatedly or touch & hold to adjust output level.
4. Touch to turn on or off of sound mute control.
5. Touch to shift to Bluetooth operation.  
Note: This icon will only be appeared when the unit has been linked up with a mobile phone.
6. Touch to shift to **BT DIAL MENU** for dial out of phone.
7. Touch to shift to **BT PHONE MENU** to show record on dial out /incoming call /missing call.
8. Touch to shift to **BT PHONEBOOK MENU** to show phonebook.
9. Touch to shift to **BT MUSIC MENU** for transmission of music playback from the connected mobile Phone.
10. Touch to shift to **BT SETUP MENU** to show the device name & pin code for pairing.  
(Note: This menu is not available for setting)

16. Touch repeatedly to select A/B repeat playback mode.
17. Touch repeatedly to select the audio output channels that recorded in the playback device.
18. Touch repeatedly to select different sub-titles that recorded in the playback device.
19. Touch repeatedly to view the angle changes in sequential order.
20. Touch repeatedly to select various slow motion playback.
21. Touch repeatedly to zoom in and zoom out of screen for viewing.
22. Touch to turn on or off of random playback.
23. Touch to activate **EQ CONTROL MENU** for various audio setting.
24. Touch to activate **AUDIO CONTROL MENU** for various audio setting.
25. Touch to rotate photo position or show up-down, left-right mirror image for viewing.
26. Touch to shift to **MUSIC FOLDER/PLAYLIST MENU** to select music folder/track for playback.
27. Touch to shift to **VIDEO FOLDER/PLAYLIST MENU** to select video folder/track for playback.
28. Touch to shift to **PHOTO FOLDER/PLAYLIST MENU** to select photo folder/track for playback.
29. Touch to show folders on **FOLDER/PLAYLIST MENU**.
30. At sub-folder playback, touch to shift to show folders on **FOLDER/PLAYLIST MENU**.
31. Touch to shift page up and down.
32. Touch to select the desired preset equalization mode. At 「 User 」 mode, frequency response can be set by user.
33. At 「 User 」 mode, hold & slide up/down of the control bar to set for the desired frequency response.
34. Touch to activate **AUDIO CONTROL MENU** for various audio setting.
35. Touch to reset the output level on front / rear / left / right speakers and it will resume to the default stage.
36. Touch to turn on or off of loudness control.
37. Hold & slide to set for the output level on front / rear / left / right speakers.
38. Touch to close **AUDIO CONTROL MENU**.
39. Touch repeatedly or touch & hold to adjust output level.
40. Hold & slide to adjust output level.
41. Touch directly to input track number for playback.
42. Touch to confirm after inputting track number for playback.
43. Touch to erase the input track number.

Note: Depends on the input device and playback media, not all the mentioned operations are available for control.

## REMOTE HANDSET – GENERAL OPERATION

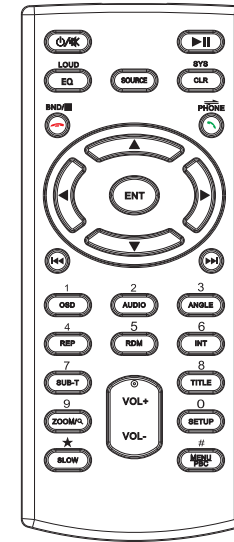

### BATTERY REPLACEMENT

Refer to the back of remote handset for details on how to replace the batteries.

NO.	SYMBOL	OPERATION & CONTROL MODES
		When the unit is turn off, press to turn on the unit. When the unit is turn on, press & hold shortly to turn off the unit.
		During unit operation, press to turn on or off of sound mute control
	SOURCE	Press repeatedly to select the desired mode for operation
	SYS / CLR	At Bluetooth mode, press to erase the digit input by error.
	EQ	Press repeatedly to select the desired preset equalization mode.
	LOUD	Press & hold shortly to turn on or off of loudness control.
	AUDIO	At video and music playback mode, each time press & hold shortly to select different audio output channels. (Note: Available on input device or media files recorded with different output channels and this selection is not available under Bluetooth mode)
	OSD	At media playback mode, press & hold shortly to display the contents of the playback details on screen. (Note: Not available at music playback mode)
	1 – 6	<b>Radio Mode</b> Press any one of the number key 1-6 to select a station that had been stored in the preset memory number key 1-6 for broadcasting.
	0 – 9	<b>Disc / USB / SD / Input Mode</b> Press directly to input the number of track for playback. <b>Bluetooth Mode</b> Press directly to input the phone number for dial out.

ZOOM



TV Mode

Press directly to input the channel number for broadcasting

Disc / USB / SD Input Mode

At video & photo playback, each time press & hold shortly to select various zoom in and zoom out of screen for viewing.

Radio Mode

Press to start scanning all the preset stations on memory and stop for a few seconds for broadcasting.

Press & hold shortly to start searching the frequency and storing the strongest signal stations into the preset memory stations number 1-6. After storing the stations, the unit starts scanning all the preset stations on memory and stop for a few seconds for broadcasting.

BND



Radio Mode

Press repeatedly to select the desired radio band for broadcasting.

Disc / USB / SD Input Mode

At playback mode, press to stop playback and shift to playlist for playback selection (depended on the input device, playlist may not be available).

Note: Not available for control at music playback mode

Bluetooth Mode

Press to hang up or refuse an incoming call.

RDM



At disc / USB / SD input playback mode, press & hold shortly to turn on or off of random playback of the input device. (Note: Not available at photo playback mode)

INT



At music playback mode, press & hold shortly to turn on or off of intro playback of the input device. (Note: Not available at Bluetooth mode)



DVD Mode

At DVD menu/title display mode, press to select the desired setting/setup and press ENT to confirm/enter.



Long press the button to adjust the view angle



Long press the button to open or close the panel

Folder / Playlist Mode

During folder/playlist display at media playback mode, press repeatedly to select track for playback. Once selected, press ENT to confirm.

Photo Playback Mode

Press to rotate photo position or show up-down, left-right mirror image.

ENT

DVD Mode / Folder/Playlist Mode

At DVD menu/title display mode as well as folder/playlist display at media playback mode, press ▲/▼/▶/◀ to select the desired setting/setup and press ENT to confirm/enter.

**FOLDER/PLAYLIST MENU**

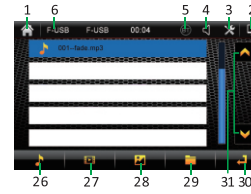

**KEYBOARD MENU**

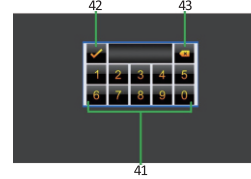

**EQ CONTROL MENU**

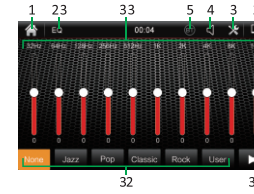

**AUDIO CONTROL MENU**

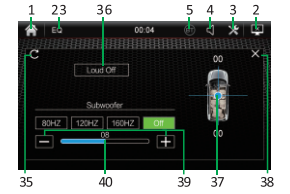

1. Touch to shift to **MAIN MENU** for various operation and setup.
2. Touch to turn off the screen. When the screen has been turned off, touch any portion of the screen to turn it on again.
3. Touch repeatedly or touch & hold to adjust output level.
4. Turn to turn on or off of sound mute control.
5. Touch to shift to Bluetooth operation.  
Note: This icon will only be appeared when the unit has been linked up with a mobile phone.
6. This shows the current input playback device.
7. Hold & slide to select the desired position (time) for playback.
8. Touch repeatedly to select repeat playback mode.
9. Touch to show title of DVD on screen. (Note: Depended on the input DVD, this function may not be operated)
10. At DVD mode, touch to show on screen the menu of the disc.  
At VCD mode, touch to shift PBC on or off. At PBC on mode, touch to start the playback at the beginning in sequence order.  
At media playback mode, touch to activate **FOLDER/PLAYLIST MENU** (available for input device recorded with folder) to select folder / track for playback.
11. Touch to activate **KEYBOARD MENU** to direct input track number for playback.
12. Touch to activate **AUDIO CONTROL MENU** for various audio setting.
13. Touch to shift to next or previous track for playback.  
Each time touch & hold shortly to activate various fast forward / fast rewind speeds for playback.
14. Touch to pause or resume playback.
15. Touch to shift to next or previous menu.



11. Touch to tune the radio frequency to upward or downward station for broadcasting.
12. Touch to select stereo (ST) or mono mode at FM radio band. When stereo signal received, stereo indicator will be appeared on screen and this is no indicator for mono signal.
13. Touch the desired preset station number ( P1–P6 ) to start broadcasting of the selected station. Touch & hold shortly the preset station number can store the current broadcasting station (frequency) into that station number.
14. Touch to close the **PRESET STATIONS MENU**.

## ON SCREEN - DISC/USB/SD CARD INPUT OPERATION

At **MAIN MENU**, touch 「DISC」 / 「F-USB」 / 「R-USB」 / 「CARD」 icon on screen to shift to multi-media playback mode and playback will start automatically. Depends on the input device and playback media, touch on screen to show various menus for operation.

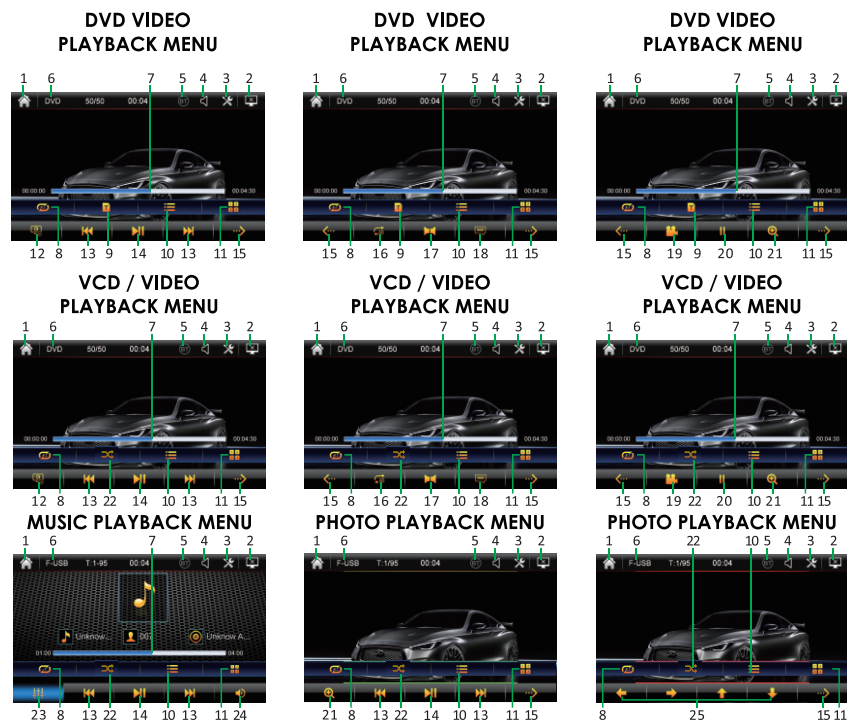

### Radio Mode

Press repeatedly to fine tune radio frequency upward or downward. Press & hold shortly to tune radio frequency upward or downward and stop for broadcasting when a station received.

### Disc / USB / SD Input Mode (Playback Mode)



Press repeatedly to shift track upward or downward for playback. Each time press & hold shortly to activate various speed of fast forward or fast rewind mode. (Note: Not available for operate at photo playback mode)

### Bluetooth Mode

Press to shift track upward or downward for playback.

### TV Mode

Press repeatedly to shift upward or downward for playback. Press & hold shortly to turn frequency upward or downward and stop for broadcasting when a channel received.

- REP At playback mode under disc / USB / SD input, each time press & hold shortly to activate various repeat playback setting.
- ANGLE At video playback mode, each time press & hold shortly to view angle changes in sequential order (available on media files recorded with this features).
- TITLE DVD Mode  
Press & hold shortly to display on screen the title of the disc for setting/setup.
- SUB-T Video Playback Mode  
Each time press & hold shortly to select different sub-titles that recoded in the input device or media files.
- SLOW At DVD playback mode, press repeatedly to select different speeds on slow motion playback.
- VOL + / VOL - Press repeatedly or press & hold to adjust sound output level.
- MENU / PBC DVD Mode  
Press & hold shortly to display on screen the menu of the entire disc for setting/setup.  
VCD Mode  
Press & hold shortly to turn on or off of PBC playback.
- SETUP During unit operation, press & hold shortly to activate setup menu on screen for various setup of the unit. Press & hold shortly again to return to previous operation mode. (Note: Setup of unit cannot be operated by remote handset. Setup of unit can only be operated by touch screen – refer to ON SCREEN OPERATION for details)
-  Bluetooth Mode  
Press to pick up an incoming call; dial out after input a phone number; redial last dial out number.
-  / PHONE Bluetooth Conversation Mode  
Press & hold shortly to shift conversation between main unit and mobile phone.

Remarks: Depends on the input devices & playback media files, operation may be varied or not available for operation.

## ON SCREEN – MAIN MENU OPERATION

Touch top left corner of screen to enter to **MAIN MENU**.

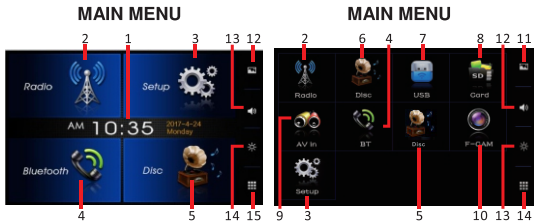

Touch the icon on the desired mode on screen and the unit will then enter into the mode that selected for operation.

Hold & slide the operation icon on screen to shift to other **MAIN MENU** that shows the hidden input or operation icons.

1. This shows the calendar and time.
2. Touch to start radio operation.
3. Touch to start various setup of the unit.
4. Touch to start Bluetooth operation (when connected to a mobile phone).
5. Touch to start Disc operation.
6. Touch to start disc input operation (when a disc inserted).
7. Touch to start USB input operation (when an USB device inserted).
8. Touch to start SD card input operation (when a micro SD card inserted).
9. Touch to start auxiliary input operation (when an auxiliary device inserted).
10. Touch to activate front camera input (when connected to a front camera and front camera switch has been turned on). When front camera input has been activated, front camera view will be displayed on screen and:
  - ~ audio output of current operation mode will be retained (for operation modes with audio output only)
  - ~ audio output of current operation mode will be broadcasted 10 seconds later (for operation modes with visual output)
  - ~ audio & visual output of current operation mode will be broadcasted 10 seconds later (for operation with video output connected)
11. Touch repeatedly for desired wallpaper (background colour) setting.
12. Touch to turn on or off of sound mute control.
13. Touch repeatedly to select brightness of screen or turn off the screen. Turn off of screen is available under headlamp detection at OFF mode. When the screen is off, touch any portion of the screen to turn it on again. Following preset brightness modes can be selected.



At this mode, brightness of screen is set by the user (user setting – refer to **SYSTEM SETUP & ILLUMINATION BACKLIGHT SETUP** under **ON SCREEN – SETUP OPERATION** for detail).

At this mode, brightness of screen is set by the user (user setting under headlamp detection at ON mode – refer to **SYSTEM SETUP & ILLUMINATION BACKLIGHT SETUP** under **ON SCREEN – SETUP OPERATION** for detail).

14. Touch to shift screen to **MAIN MENU**.

## VERSION OF UNIT

### VERSION OF UNIT

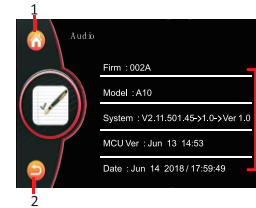

1. Touch to shift screen to **MAIN MENU**.
2. Touch to shift to previous menu or operation mode.
3. These show the software version of unit.

Note: The **VERSION OF UNIT** is used to show the details of unit. This is not available for setting.

## ON SCREEN – RADIO OPERATION



At **MAIN MENU**, touch to shift screen to **RADIO MENU** for radio operation.

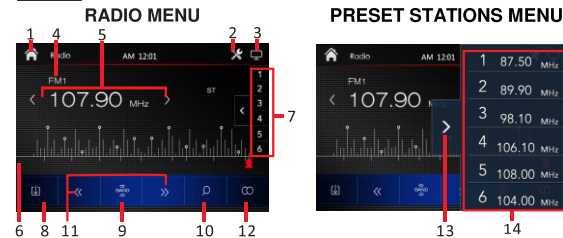

1. Touch to shift screen to **MAIN MENU**.
2. Touch to activate audio & visual setting for various audio & visual setup (refer to **ON SCREEN – AUDIO & VISUAL SETTING** for details).
3. Touch to turn off the screen. When the screen turned off, touch any portion of the screen to turn on the screen.
4. Touch to select FM & AM radio band for broadcasting.
5. Touch to manual select the desired radio frequency
6. Hold & slide to select the desired radio frequency for broadcasting.
7. Touch to activate the **PRESET STATIONS MENU** on screen.
8. Touch to start searching the radio frequency & storing the strongest signal stations into memory stations (P1 – P18). After one cycle searched, the unit starts into broadcasting of the preset memory stations for a few seconds.
9. Touch repeatedly to select desired radio band, FM1, FM2, FM3, AM1, AM2
10. Touch to start into broadcasting of the preset memory stations for a few seconds. Touch again to stop this into broadcasting.

- When AUTO MODE selected, touch to activate AUTO CYCLE TIME INTERFACE to select the time for automatic backlight change.
- Touch to select AUTO MODE for automatic backlight change (cycle change).
- When MANUAL MODE selected, touch to activate **R.G.B. MENU** for R/G/B adjustment.
- Touch to select PRIMARY MODE to select a single colour illumination.
- When PRIMARY MODE selected, touch to activate COLOUR INTERFACE to select a single colour for illumination.
- Hold & slide to set brightness of screen when brightness of screen is set at USER MODE (refer to ON SCREEN – MAIN MENU OPERATION):



- Hold & slide to set brightness of screen when brightness of screen is set at USER SETTING MODE under headlamp detection at ON mode (refer to ON SCREEN – MAIN MENU OPERATION):



- At **R.G.B. MENU**, hold & slide to adjust the desired R / G / B colour.

Note: Backlight illumination is synced with the on/off of the car lamp. Orange wire should be connected to the on/off of car lamp

## STEERING WHEEL CONTROL SETUP

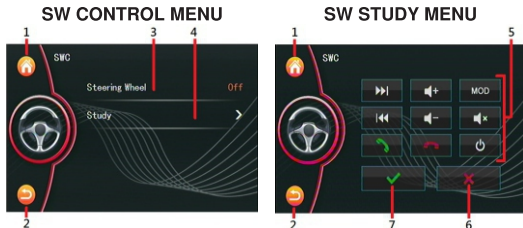

- Touch to shift screen to **MAIN MENU**.
- Touch to shift to previous menu or operation mode.
- Touch to turn on or off of steering wheel control (when the steering wheel control wires – grey & green as well as the ground wire connected).
- Touch to activate **SW STUDY MENU** for steering wheel control learning & setting.  
Steps for learning & setting:  
~ touch any control key "5" on screen  
~ press & hold the respective control of the steering wheel of the car  
~ the unit starts learning and once completed, indicator appears on screen  
~ follow the above steps to set for all other controls  
~ when completed, press "7" to confirm the setting  
~ press "6" to cancel the setting
- These show items available for setting.
- Touch to cancel the setting.
- When study & setting completed, touch to confirm the setting.

## ON SCREEN – AUDIO & VISUAL SETTING



During unit operation and when this icon appeared on screen, touch to activate audio & visual setting for various audio & visual setup.



### Volume Control

- Touch to shift to Volume Control Menu.
- Hold & slide to adjust sound output level.
- Touch to turn on or off of sound mute control.

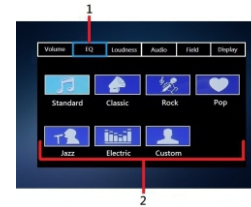

### Preset Equalization Control

- Touch to shift to Preset Equalization Control.
- Touch to select the desired preset equalization mode. At Custom mode, it is set by the user (Refer to AUDIO SETUP under ON-SCREEN – SETUP OPERATON).



### Loudness Control

- Touch to shift to Loudness Control.
- Touch to turn on or off of loudness.

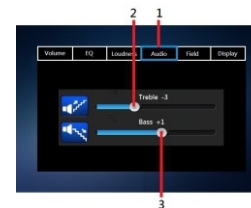

### Audio Control

- Touch to shift to Audio Control.
- Hold & slide to adjust output level on treble.
- Hold & slide to adjust output level on bass.

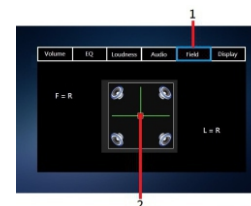

### Field Control

- Touch to shift to Field Control.
- Hold & slide to set for the output level on left / right / front / rear speaker.

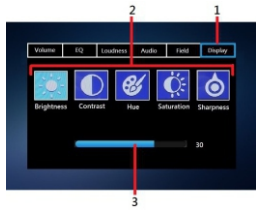

#### Visual Control

1. Touch to shift to Display Control.
2. Touch to select the desired setting mode on brightness, contrast, hue, saturation and sharpness.
3. At the desired setting mode, hold & slide to adjust the level.

### ON SCREEN – SETUP OPERATIOPN



At **MAIN MENU**, touch to shift screen to **SETUP MENU** for various setup selection of the unit.

#### UNIT SETUP

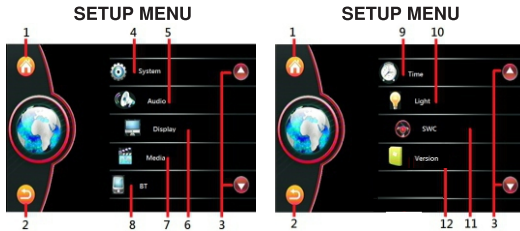

1. Touch to shift screen to **MAIN MENU**.
2. Touch to shift to previous menu or operation mode.
3. Touch to shift page up or down.
4. Touch to shift to **SYSTEM SETUP MENU** for various system setting (Refer to SYSTEM SETUP).
5. Touch to shift to **AUDIO SETUP MENU** for various audio setting (Refer to AUDIO SETUP).
6. Touch to shift to **VISUAL SETUP MENU** for various visual setting (Refer to VISUAL SETUP).
7. Touch to shift to **MEDIA SETUP MENU** for various media setting (Refer to MEDIA SETUP).
8. Touch to shift to **BLUETOOTH SETUP MENU** for various Bluetooth setting (Refer to BLUETOOTH SETUP).
9. Touch to shift to **CALENDAR SETUP MENU** for calendar & clock setting (Refer to CALENDAR & CLOCK SETUP).
10. Touch to shift to **LIGHT SETUP MENU** for various illumination backlight setting (Refer to ILLUMINATION BACKLIGHT SETUP).
11. Touch to shift to **SWC SETUP MENU** for steering wheel control setting (Refer to STEERING WHEEL CONTROL SETUP).
12. Touch to shift to **VERSION MENU** to show details of the unit (Refer to VERSION OF UNIT).

#### CALENDAR FORMAT MENU

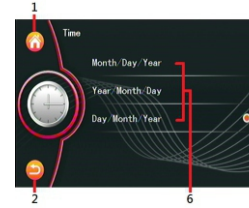

#### CLOCK FORMAT MENU

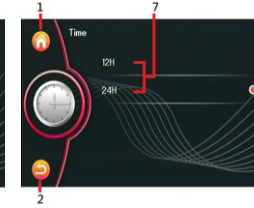

#### SETTING MENU

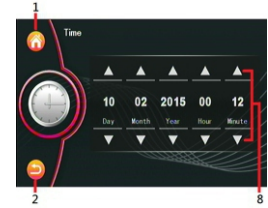

1. Touch to shift screen to **MAIN MENU**.
2. Touch to shift to previous menu or operation mode.
3. Touch to activate **CALENDAR FORMAT MENU** for date / month / year format setting.
4. Touch to activate **CLOCK FORMAT MENU** for 12H / 24H display format setting.
5. Touch to activate **SETTING MENU** for calendar & clock setting.
6. Touch to select calendar display format.
7. Touch to select clock display format.
8. Touch repeatedly to set for calendar & clock.

### ILLUMINATION BACKLIGHT SETUP

#### LIGHT (AUTO) SETUP MENU

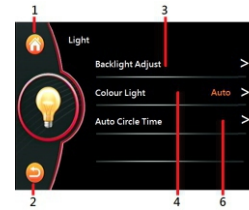

#### LIGHT (MANUAL) SETUP MENU

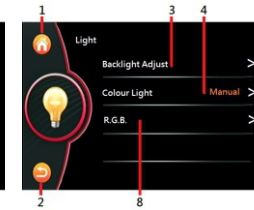

#### LIGHT (PRIMARY) SETUP MENU

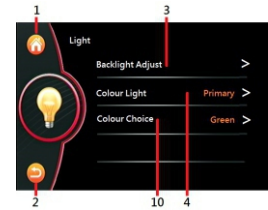

#### MODE MENU

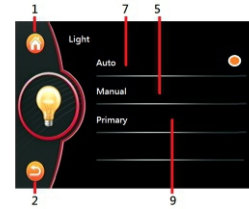

#### ADJUST MENU

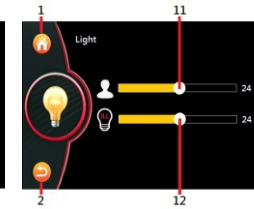

#### R.G.B. MENU

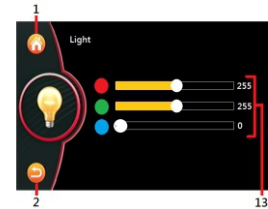

1. Touch to shift screen to **MAIN MENU**.
2. Touch to shift to previous menu or operation mode.
3. Touch to activate **ADJUST MENU** to adjust backlight illumination.
4. Touch to activate **MODE MENU** to select illumination mode (auto / manual / primary).
5. Touch to select **MANUAL MODE** for R.G.B. colour setting.

1. Touch to shift screen to **MAIN MENU**.
2. Touch to shift to previous menu or operation mode.
3. Hold & slide to show the hidden Bluetooth setup modes.
4. Touch to turn on or off of Bluetooth operation mode.
5. Touch to activate **KEYBOARD MENU** for renaming the device (default name "CAT KIT")
6. Touch to activate **PIN CODE MENU** for changing the pin code of the device.  
(Note: Default pin code "0000" or "8888").
7. Touch to turn on or off of auto linking between the car unit and mobile phone when the car unit turned on again after power off.
8. Touch to turn on or off of auto answer when receiving incoming call.
9. Touch to turn on or off of automatic loading record of incoming calls / dial out numbers / missing calls of the mobile phone to the car unit.  
(Note: Loading of record will start automatically when the unit linked up with the mobile phone & shift to **BT RECORD MENU** at the first time – refer to ON SCREEN – BLUETOOTH OPERATION for details)
10. Touch to turn on or off of automatic loading phone book of the mobile phone to the car unit.  
(Note: Loading of phone book will start automatically when the unit linked up with the mobile phone & shift to **BT PHONE BOOK MENU** at the first time – refer to ON SCREEN – BLUETOOTH OPERATION for details)
11. Touch to turn on or off of the default volume level during Bluetooth conversation.  
ON mode: volume level at Bluetooth conversation is shifted to the default volume level  
OFF mode: volume level at Bluetooth conversation is the same level at current volume level  
Note: Volume level can be adjusted at any time during Bluetooth conversation
12. Touch to input the new name of the device.
13. Touch to shift between capital letter & small letter.
14. Touch to erase the digit / letter input by error.
15. Touch for spacing.
16. Touch to confirm the input.
17. Touch to input the new pin code of the device.
18. Touch to erase the digit input by error.
19. Touch to confirm the input.

## CALENDAR & CLOCK SETUP

### CALENDAR SETUP MENU

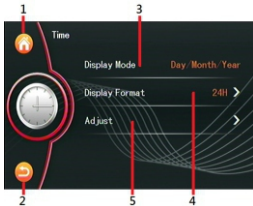

## SYSTEM SETUP

### SYSTEM SETUP MENU



### SYSTEM SETUP MENU

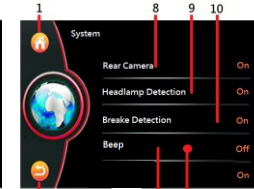

1. Touch to shift screen to **MAIN MENU**.
2. Touch to shift to previous menu or operation mode.
3. Hold & slide to show the hidden setting modes.
4. Touch to activate **AREA INTERFACE** to select the country or area located (for the radio frequency that suits the country or area that located).
5. Touch to activate **LANGUAGE INTERFACE** to select the desired system language on screen.
6. Touch to activate **PASSWORD INTERFACE** to input password for opening scene logo setting.  
Remarks: This setting is for ex-factory setting and not available for user setup
7. Touch to turn on or off of front camera input (when front camera connected):  
~ when the front camera input is turn on and the car is shifted from backward mode to forward mode, front camera input will be display for 10 seconds  
~ the default setting after first installation is off and at this moment, no front camera input will be display when the car is shifted from backward mode to forward mode
8. Touch to turn on or off of rear camera input (when rear camera and the pink wire connected).
9. Touch to turn on or off of headlamp detection of the car (when the orange wire connected with the on/off of car headlamp).  
ON mode: when the headlamp of the car turned on, brightness of screen will shift to the default setting by user. User can also adjust the brightness of screen at this mode (refer to **ILLUMINATION BACKLIGHT SETUP** for details)  
OFF mode: when the headlamp of the car turned on, brightness of screen will not be affected
10. Touch to turn on or off of allowing watching video during driving (when the brake – brown wire has not been connected).
11. Touch to turn on or off of beep sound when touching on screen for control.

## AUDIO SETUP

### AUDIO SETUP MENU

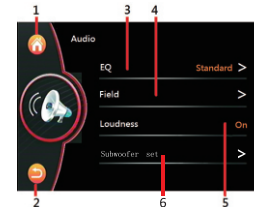

### EQ MENU

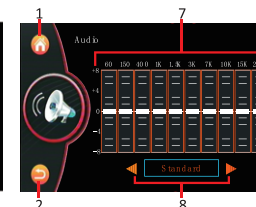

## FIELD MENU

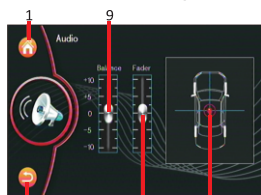

## SUBWOOFER MENU

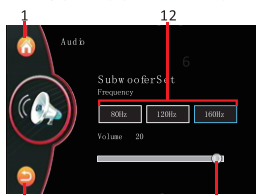

1. Touch to shift screen to **MAIN MENU**.
2. Touch to shift to previous menu or operation mode.
3. Touch to activate **EQ MENU** for equalization setting.
4. Touch to activate **FIELD MENU** for sound output setting on balance & fader.
5. Touch to turn on or off of loudness control.
6. Touch to set the Frequency and adjust the Subwoofer volume.
7. At custom control mode, hold & slide to set for the desired equalization level.
8. Touch repeatedly to select the desired preset equalization mode.
9. Hold & slide to adjust the output level between left & right speaker.
10. Hold & slide to adjust the output level between front & rear speaker.
11. Hold & slide to set for the desired output level between left & right speaker as well as front & rear speaker.
12. Choose difference frequency
13. Hold & slide to adjust output level.

## MEDIA SETUP

### MEDIA SETUP MENU

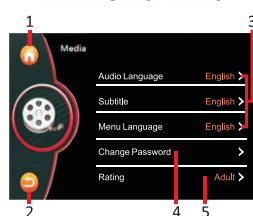

### MEDIA SETUP MENU

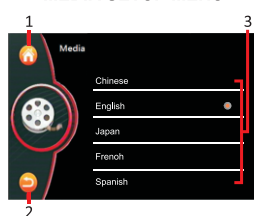

### KEYBOARD MENU

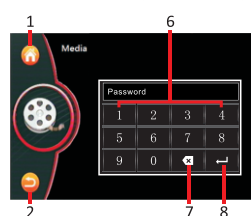

1. Touch to shift screen to **MAIN MENU**
2. Touch to shift to previous menu or operation mode.
3. Before inserting a DVD for playback, touch to set the desired audio language, subtitle and menu language provided the DVD recorded with relative sources. (Note: Settings are not activated during DVD playback)
4. Touch to activate **KEYBOARD MENU** for password changing. (Default password "0000" "8888")
5. Touch to activate **KEYBOARD MENU** to input password in order to select rating for video playback. (Default password "0000" or "8888")
6. Touch to input the new pin code of the device.
7. Touch to erase the digit input by error.
8. Touch to confirm the input.

## VISUAL SETUP

### VISUAL SETUP MENU

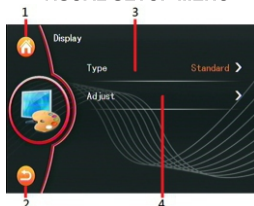

### PRESET VISUAL MENU

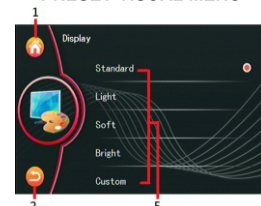

### CUSTOM VISUAL MENU

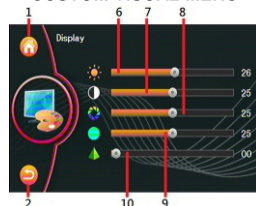

1. Touch to shift screen to **MAIN MENU**.
2. Touch to shift to previous menu or operation mode.
3. Touch to activate **PRESET VISUAL MENU** for preset visual setting.
4. Touch to activate **CUSTOM VISUAL MENU** for visual setting.
5. Touch to select the desired preset visual mode of screen. (Note: At "Custom" mode, visual setting on brightness, contrast, hue, saturation & sharpness are made by user under **CUSTOM VISUAL MENU**)
6. Hold & slide to adjust brightness of screen.
7. Hold & slide to adjust contrast of screen.
8. Hold & slide to adjust hue of screen.
9. Hold & slide to adjust saturation of screen.
10. Hold & slide to adjust sharpness of screen.

## BLUETOOTH SETUP

### BLUETOOTH SETUP MENU

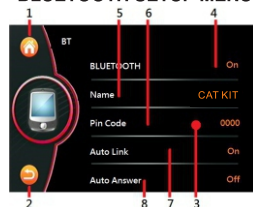

### BLUETOOTH SETUP MENU

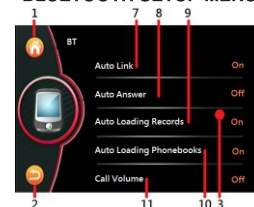

### KEYBOARD MENU

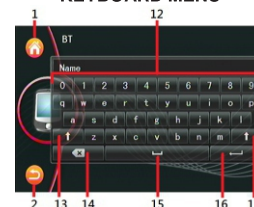

### PIN CODE MENU

