

POWER ACOUSTIK

Operation Instruction Manual CPAA-70D



Content

1. Appearance	3
2. Accessories and Installation	4
3. Wiring Connection	6
4. Front panel Description	7
5. Remoto Control	8
6. Main Menu.....	9
7. Settings	10
8. Apple CarPlay & Android auto	15
9. Radio.....	17
10. USB	18
11. Disc	20
12. BT Music	22
13. BT Phone.....	24
14. Aux IN	29
15. Specification	30
FCC Notes	31

1. Appearance

Main Menu

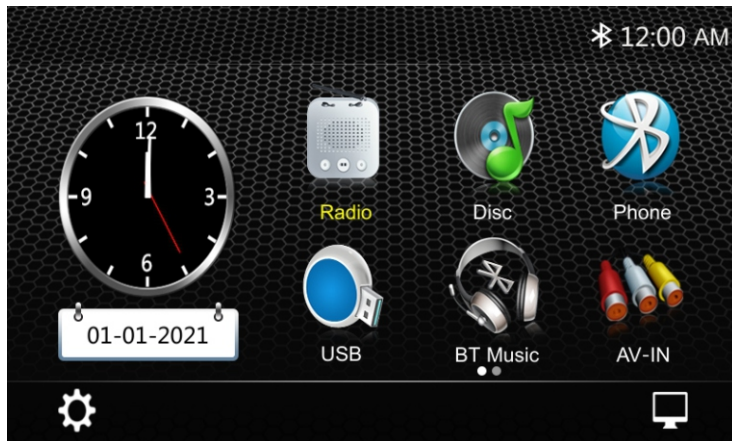

Carplay Menu

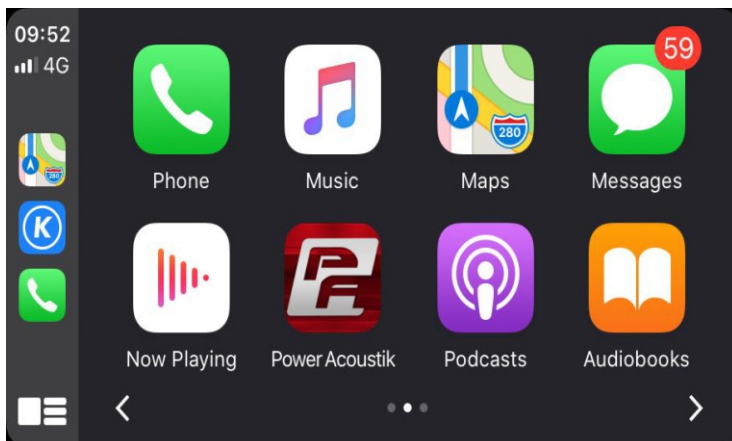



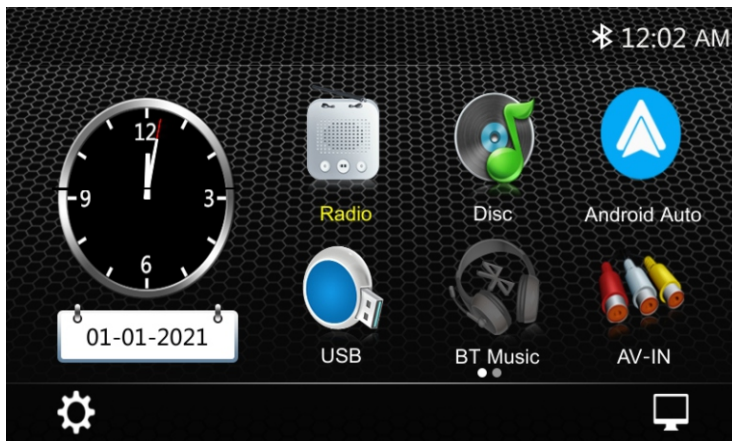

Android Menu

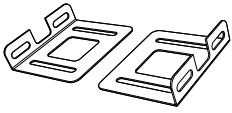
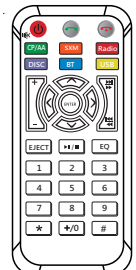
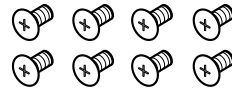

2. Accessories & Installation

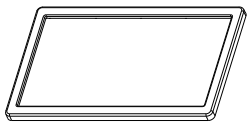
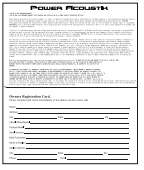
Package contains the following accessories for installation and operation of the unit.

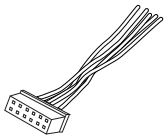
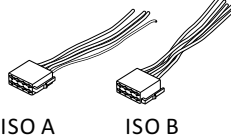
(1) Mounting bracket	2		(3) Remote	1	
(2) Screw	8		(5) User Manual	1	
(4) Trim Ring	1		(7) Warranty Card	1	
(6) Download Card,	1		(9) Harness cable	1	
(8) ISO Cable	2	 ISO A ISO B			

Installation

Round head Screws

1. Put the 2 brackets to the left and right side of the head unit
2. Use screws to fix the brackets to the unit.

Note:

1. Make sure the ignition is turned off, and disconnect the cable from the vehicle battery's negative (-) terminal. You never want electricity running while you install this 2-DIN car receiver.
2. Before installation, disconnect the wire harness and the antenna.
3. Attach the brackets on the both sides of the car receiver with screws as shown as the figure. Please buy from your dealer according to the drilling of holes size.

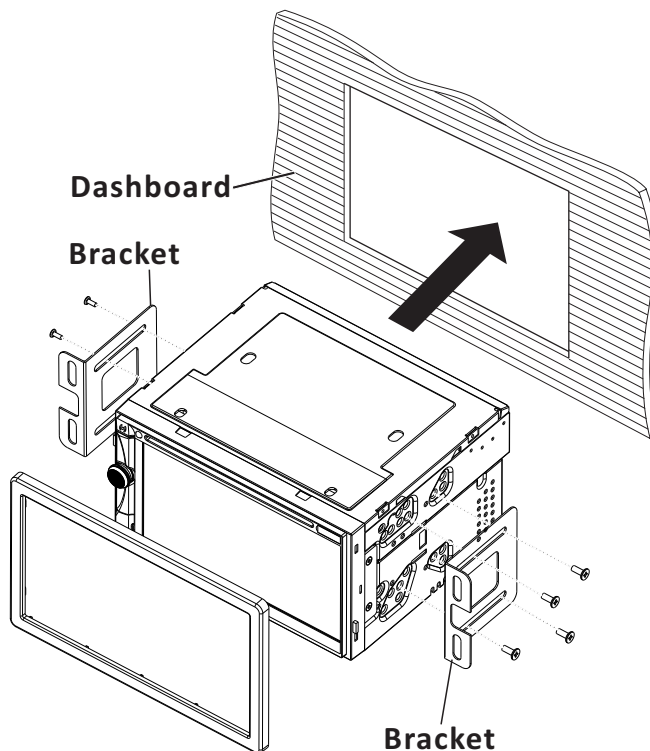

Installation

4. Consult with your nearest dealer if installation requires the drilling of holes or other modification of the vehicle.
5. Install the car receiver in the dashboard.
6. Connect the wire harness & antenna to the car receiver being carefully not to pinch any wires or cables.
7. Install the plastic outer trim ring onto the car receiver.
8. Reconnect the battery and run through all of the options on this car receiver to ensure that everything is working correctly.
9. Particulars will vary widely depending upon the kind of your car and the car you intend to install it in. Please choose the correct installation method according to the actual situation of your car. Always contact the car dealer or manufacturer if you have any questions.

3. Wiring Connection

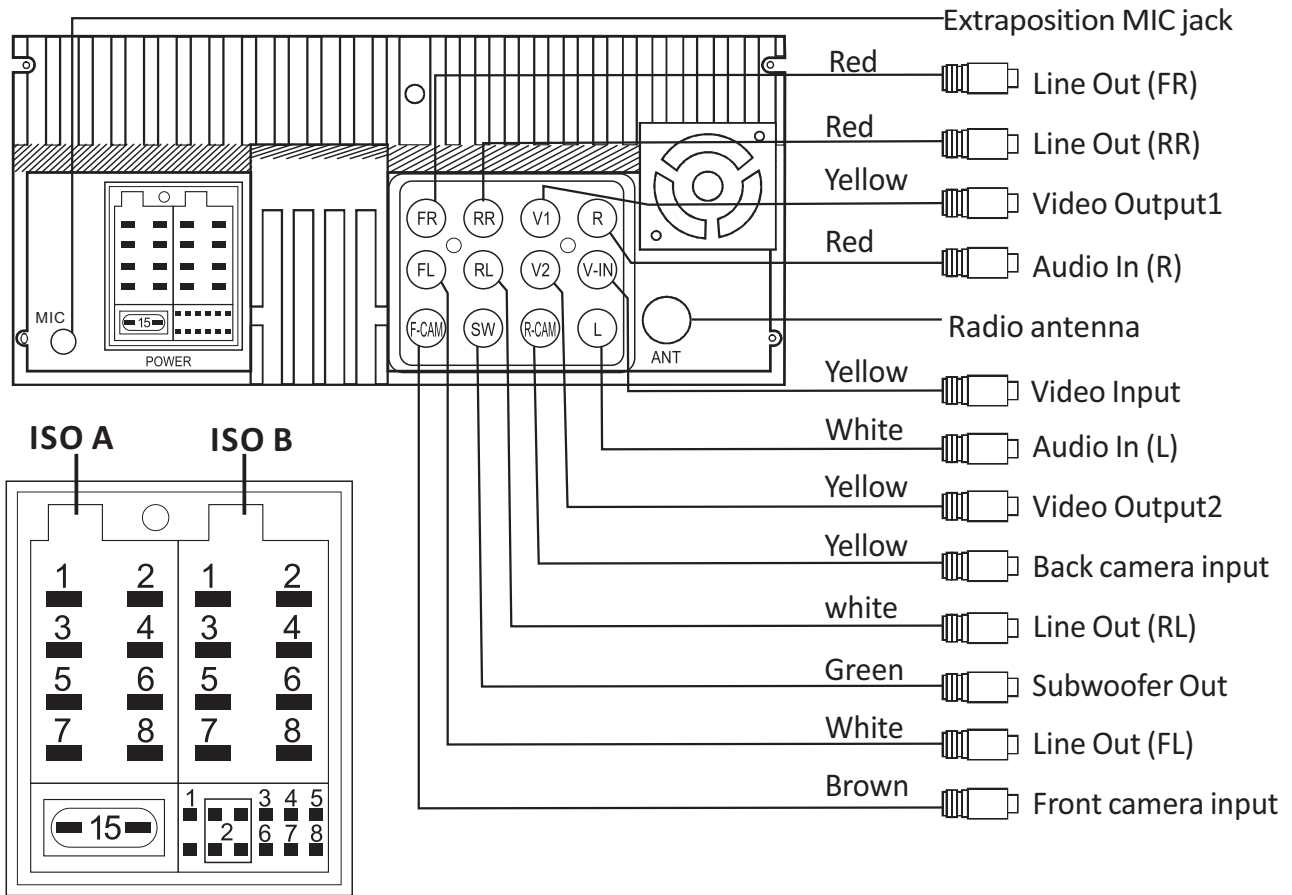

Portion	Color	Connection
ISO A	Yellow	Battery B+
	Orange	ILL B+
	Blue	Antenna
	Black	Ground
	Red	ACC B+
ISO B	Purple	Rear right speaker(+)
	Purple / Black	Rear right speaker(-)
	Grey	Front right speaker(+)
	Grey / Black	Front right speaker(-)
	White	Front left speaker(+)
	White / Black	Front left speaker(-)
Harness connector	Green	Rear left speaker(+)
	Green / Black	Rear left speaker(-)
	Blue / White	Amplifier control(B+)
	Brown	Brake detect (Ground)
	Pink	Back car control(Back camera B+)
	Pink / Black	Front camera(B+)
	Black	Ground
Green	Steering Wheel 2	
Grey	Steering Wheel 1	

4. Front Panel

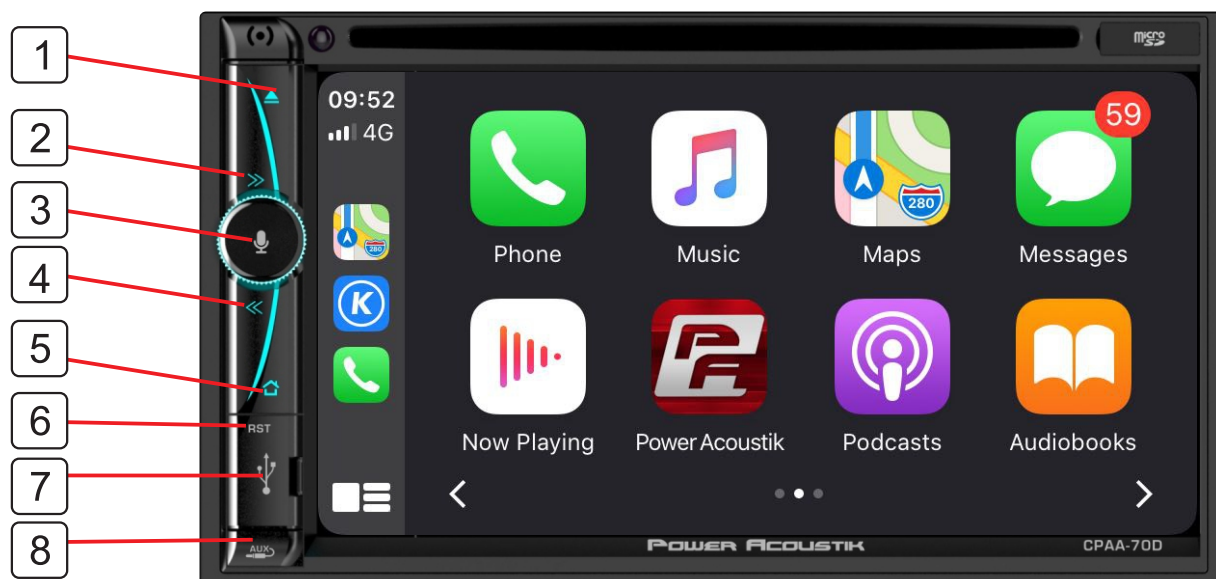

① Eject

eject disc.

② ④ >> / <<

Radio Mode:

Press repeatedly to fine tune the radio frequency upward or downward.

Press & hold shortly to tune the radio frequency to the upward or downward station for broadcasting.

Disc/USB / SD Input Mode / Bluetooth Mode:

Press repeatedly to shift track upward or downward for playback.

Each time press & hold shortly to activate various fast forward/rewind speeds for playback.
(Note: Fast forward or fast rewind is not available at Bluetooth mode & picture playback mode)

③ VOLUME

when Apple CarPlay or Android Auto available, hold the voice button to start the voice control function.

⑤ HOME

when Apple CarPlay or Android Auto available, hold the voice button to start the voice control function.

⑥ RESET

Restart Head unit.

⑦ USB

Insert USB device to this slot for digital files playback.(Note: the USB slot is intended for data transfer only, carplay,android auto and charging.

⑧ AUX

Insert an external device to this port in order to have sound output of that external device through the unit

5. Remote Control

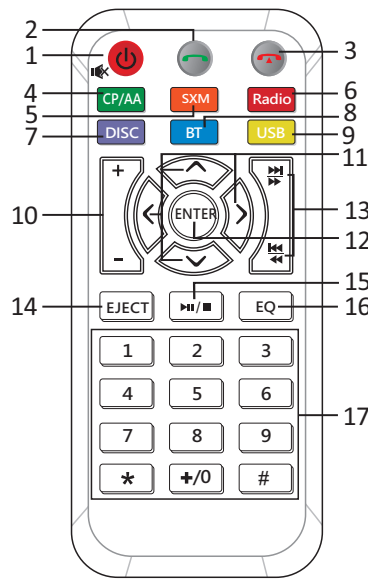

No.	SYMBOL	OPERATION & CONTROL MODES
1.		Press and hold to power it on or off. Short press this button mute the volume output when unit turn on. Long press is Power OFF function when unit turn on.
2.		<u>In Bluetooth Mode:</u> Press it to make a call after inputted a phone number or answer an incoming call.
3.		<u>In Bluetooth Mode:</u> Press it to reject a coming call or hangup while calling
4.	CP/AA	Press it to switch to Carplay or Android Auto mode; Head Unit will show string "invalid operation" when CP/AA is not plugged in in Head Unit.
5.	SXM	Press it to SXM mode. (Only for SXM models).
6.	Radio	Press it to Radio mode.
7.	DISC	Press it to DVD mode.
8.	BT	Press it to Bluetooth mode.
9.	USB	Press it for digital files playback in USB
10.	VOL+/-	Press it to increase or decrease the volume level.
11.		It is UP /Down/Left/Right Arrow, use this button to select the menu item, the title track or to show next frame.
12.	ENTER	Press it to confirm selection.
13.		<u>In DVD mode:</u> short press it to skip to the next track or previous functions, long press to activate fast forward or fast review in a track
14.	EJECT	Press it to eject the disc.
15.		<u>In DVD mode:</u> press it to stop playback, press again to resume.
16.	EQ	Press it to Equalizer functions.
17.	0-9 * #	<u>In Radio mode:</u> select 1-6 the desired band; <u>In DVD mode:</u> select track. <u>In Bluetooth mode:</u> 0-9 * # enter the phone number or input password.

- Note:**
1. "SXM" just for include SiriusXM function model.
 2. "*" "#" these functions for Bluetooth.

6.MAIN MENU

CPAA-70D is a Two Din Car Audio with the following functions:

Apple CarPlay, Google Android Auto, Radio, Disc, Bluetooth Audio, USB.

The MODE icon in grey mean the corresponding function is not ready or proper device have not been connected.

Touch the corresponding MODE icon to enter playing mode.



without Apple CarPlay



with Apple CarPlay



with Android Auto



Setup, to enter the Settings Menu.



turn off TFT display. TFT enter black mode touch any zone return to TFT on.

7.Settings

Touch the  icon to enter the Setup menu.

The Setup menu is included Time Settings, Audio Settings, Disc Settings, General Settings, Wallpapers Settings.

Time Settings

The Time Settings allow the user to set, Date & Time.

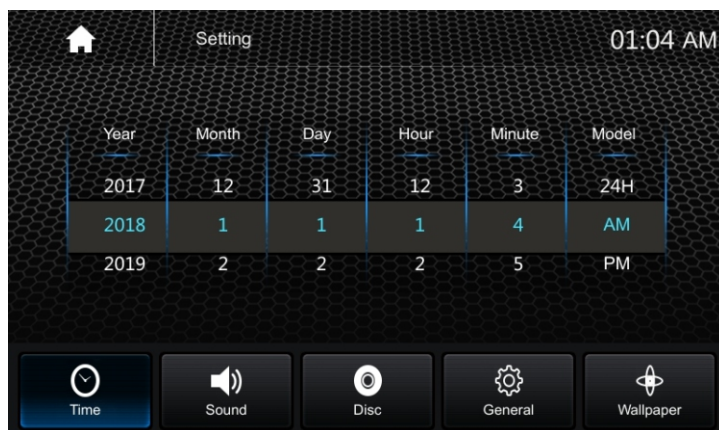

Sound Settings

Below shown is the Sound Settings Menu.

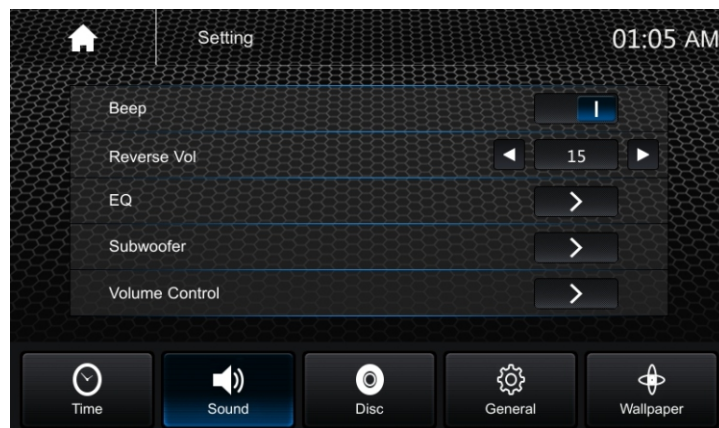

EQ Settings

Balance / Fader / Loud:

Loud: Touch the ◀ or ▶ to set the LOUD function is ON/OFF.

Touch the ◀ or ▶ of Balance/Fade to tune for the driver and passenger preference.

The value of Balance (Left 12 – Right 12) and Fade (Front 12 – Rear 12)

Touch **Reset** to set both Balance and Fader to 0.

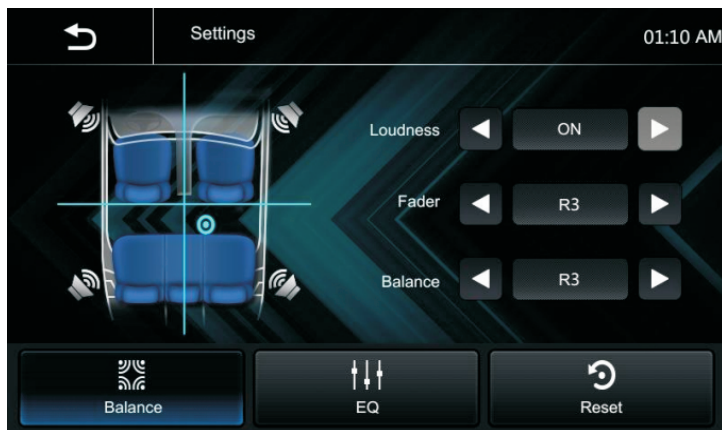

10- Band Equalizer

10 band of EQ tuning, slide the EQ bar to tune each band frequency level according to user preference.

Touch **Reset** to set all Band to 0.

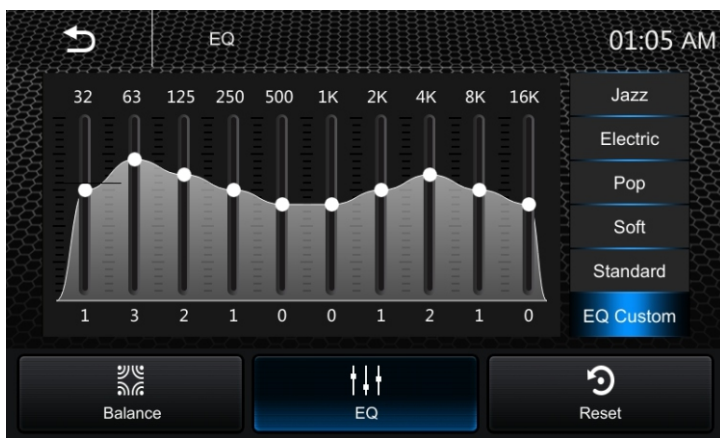

Disc Setting

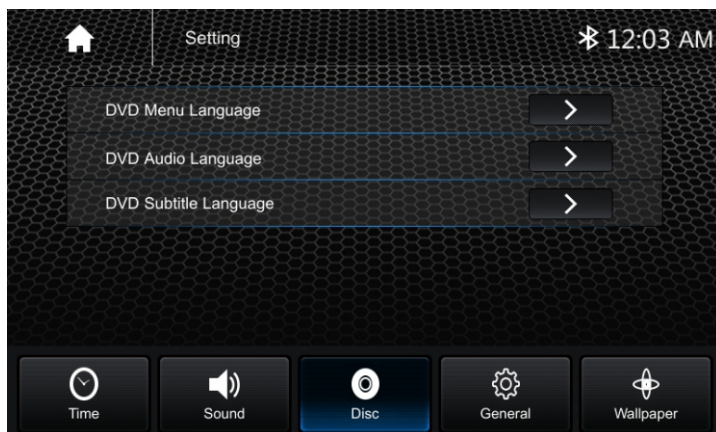



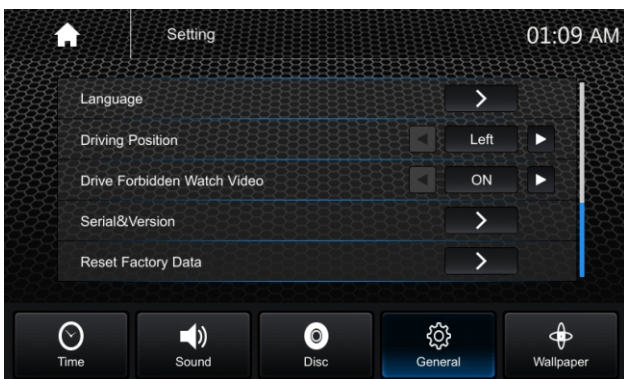
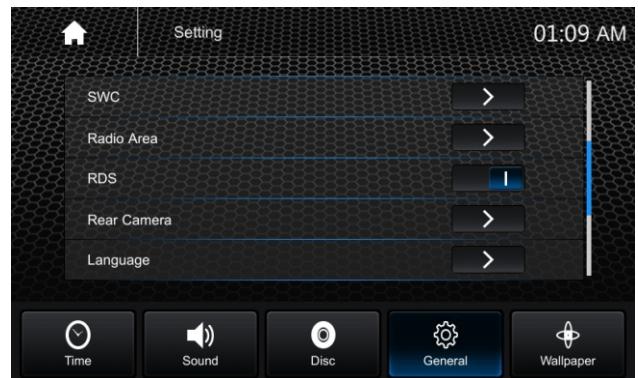
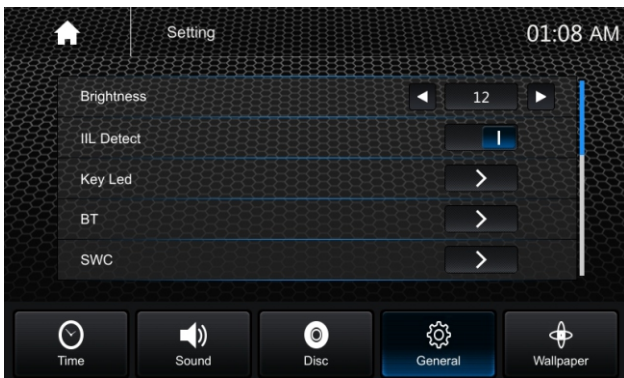

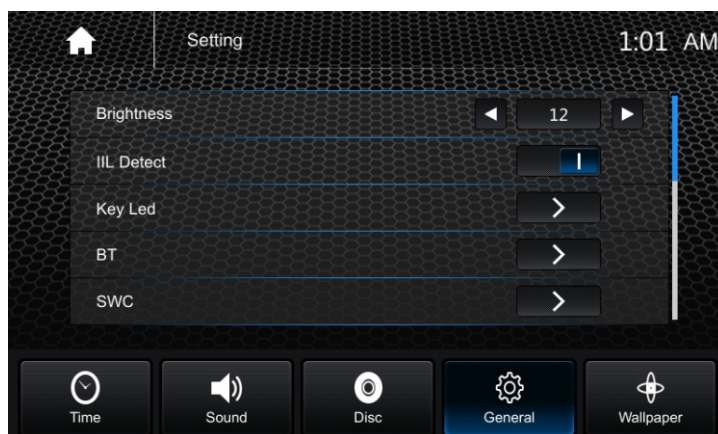

General Setting

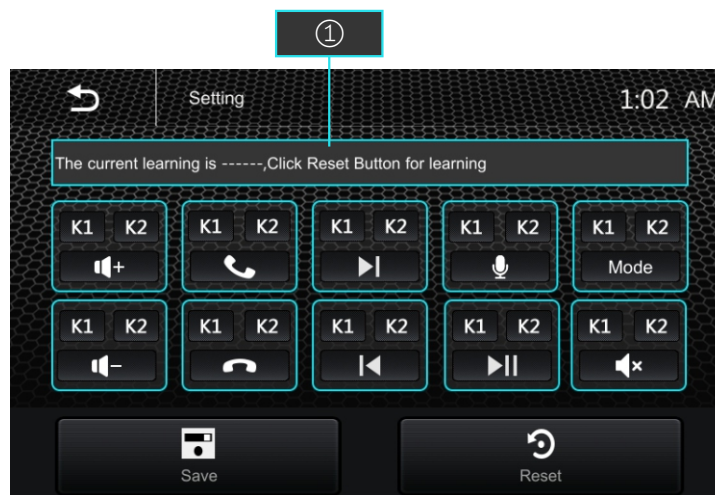
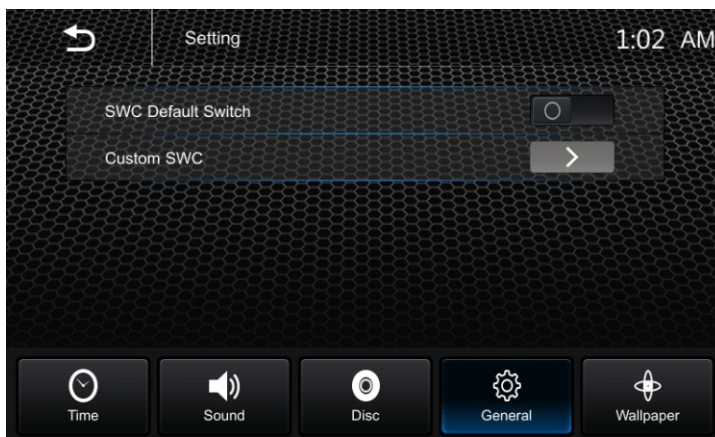

Steering Wheel Control Setting





-  Touch **SWC** for Steering Wheel Control setting
-  Click **SWC Default Switch** to be "on" status
-  Click **Custom SWC** to SWC study model
-  Press the steering wheel control button of the car first and then touch the corresponding button on player screen for learning and setting
-  Touch **Save** to confirm the setting
-  Touch **Reset** to erase and reset the setting

Radio Area

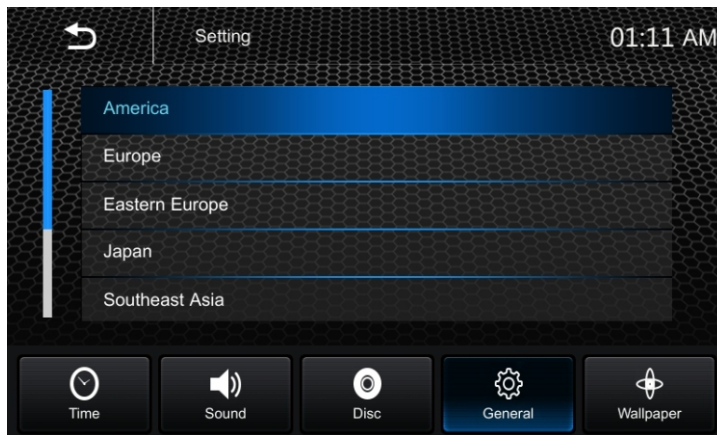

Serial & Version

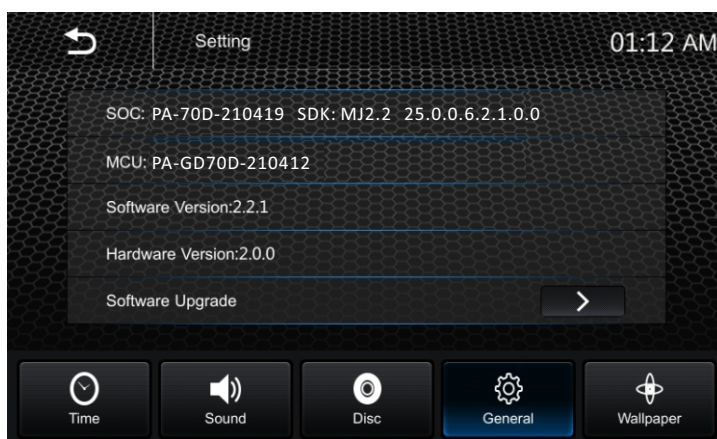

Wallpaper

User can select the preset wallpaper.

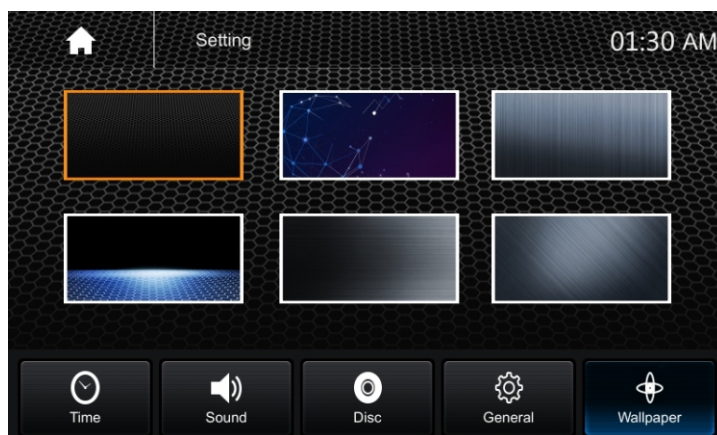

Touch the corresponding picture to select the prefer background.



8. Apple CarPlay & Android auto

8.1 Apple Carplay

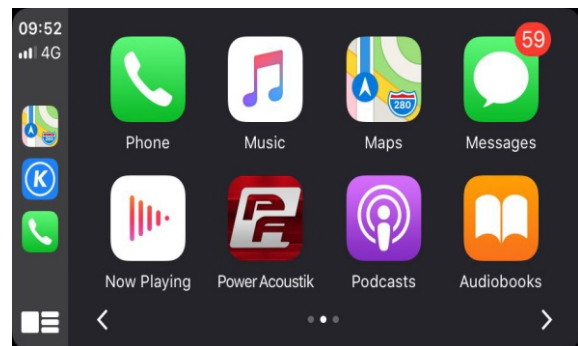
Plug the iPhone (iPhone 5 or latter models, and iOS 7.1 or above) through the lightening cable to the USB port of the Head unit. The iPhone will be shown the “CarPlay”. The Head unit will enter the CarPlay interface, the APP that support the CarPlay feature will be displayed on the Head Unit as shown below. Touch the corresponding APP can operation the operation, touch the  button to go back to the CarPlay interface.



Siri

In CarPlay mode, user can talk to SIRI to control the CarPlay function. Press  button to start the SIRI function, or touch the  button for 2 second or the HOME button of iPhone in the CarPlay Home screen to talk to Siri for playing music, i will going

Notice: For the SIRI function in the Head unit, the Microphone has to been connected.

In CarPlay model, touch “Home/siri ” button or  icon to enter the Head unit main menu

8.2 Android auto Operations

Android Auto enables you to use functions of your Android device convenient for driving. You can easily access route guidance, make calls, listen to music, etc. For details about Android Auto, visit <https://www.android.com/auto/> and <https://support.google.com/androidauto/>.

Compatible Android devices

You can use Android Auto with Android devices of Android version 5.0 or later.

Note: Android Auto may not be available on all devices and is not available in all countries or regions.

Operations:

1. Connect an Android device via USB terminal

To use the hands-free function, connect the Android device via Bluetooth.

When an Android device compatible with Android Auto is connected to USB terminal, the device is connected via Bluetooth automatically, and the Bluetooth smartphone currently connected is disconnected.



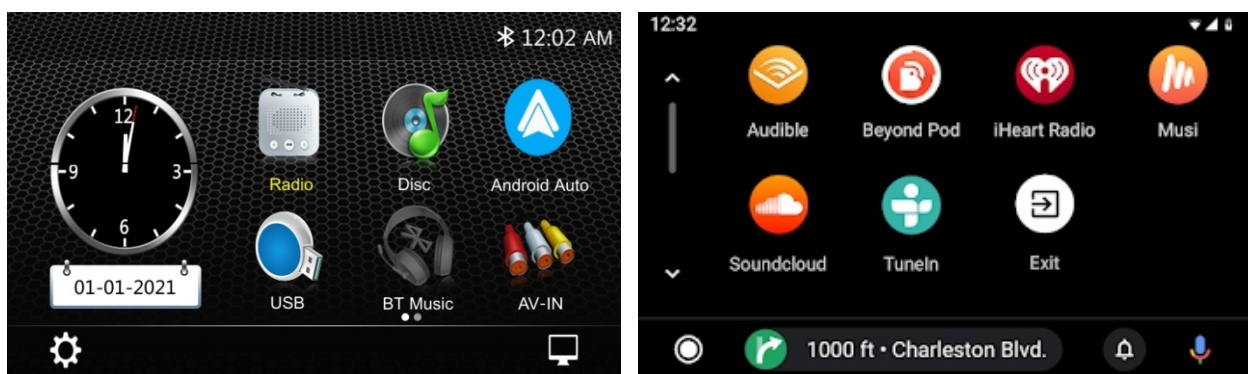





2. Unlock your Android device
3. To enter Android Auto mode, touch Android Auto icon in the head unit screen.
You can perform the operations of the Apps of the connected Android device.
4. In Android Auto model, touch "Home" to the head unit main menu.

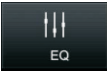
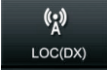

9. Radio mode

Touch the **Radio** icon to enter Radio mode.



-  Touch FM1 button to select FM1 BAND
-  Touch AM1 button to select AM1 BAND
-  Touch it to select the band, FM1->FM2->FM3->AM1->AM2
-  Touch it for the Auto Scan searching.
-  Touch it to enter EQ setting
-  Touch it to select loc or Dx
-  Touch it to direct tune
-  Short touch for Tune-, long touch for Seek-.
-  Short touch for Tune+, long touch for Seek+.
-  Preset channel, Six preset buttons store and recall stations for each band.

Store a Station

1. Tune radio to desired station.
2. Touch and hold the one of the preset channel button for more than 3 seconds, then the preset buttons will be highlighted on the screen, and the preset station will be store.

10.USB

Plug the USB to the connector, the USB icon will have color. Touch the USB icon to enter the USB playback mode. The Head unit default to play the Audio in the USB driver.

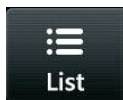

Press to search Audio, Video or Picture files.

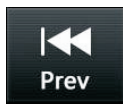

Short press it to skip to the previous track, long press it to fast reverse.

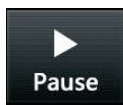

Pause/Play button.

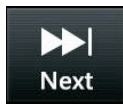

Short press it to skip to the next track, long press it to fast forward.

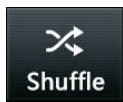

Press it to turn on/off random play.



Repeat Play Press it to select Repeat All, Repeat One or Repeat Directory.

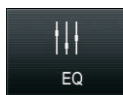

Press it to select the Audio setting or set the prefer EQ of each band in Custom mode

Filelist browsing

CPAA-70D is default audio play back, it also support to play picture and video. If there is other

multimedia files in the USB, touch  to browse the folder and file list of the USB driver. Select the multimedia type

 Return to playing pervious file

 Select Audio or Music files

 Select Movie or Video files.

 Select Picture files

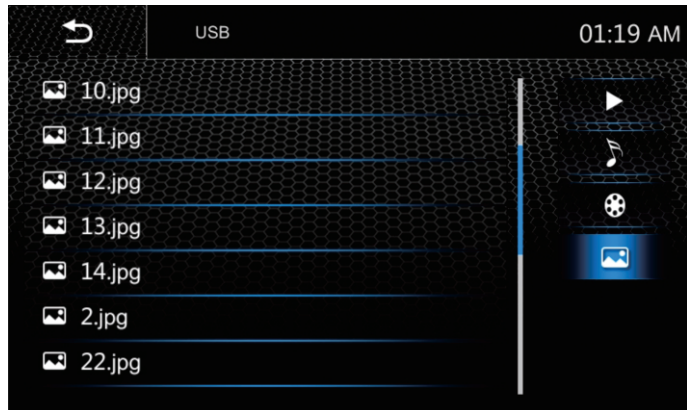

11. Disc (Playing Video)

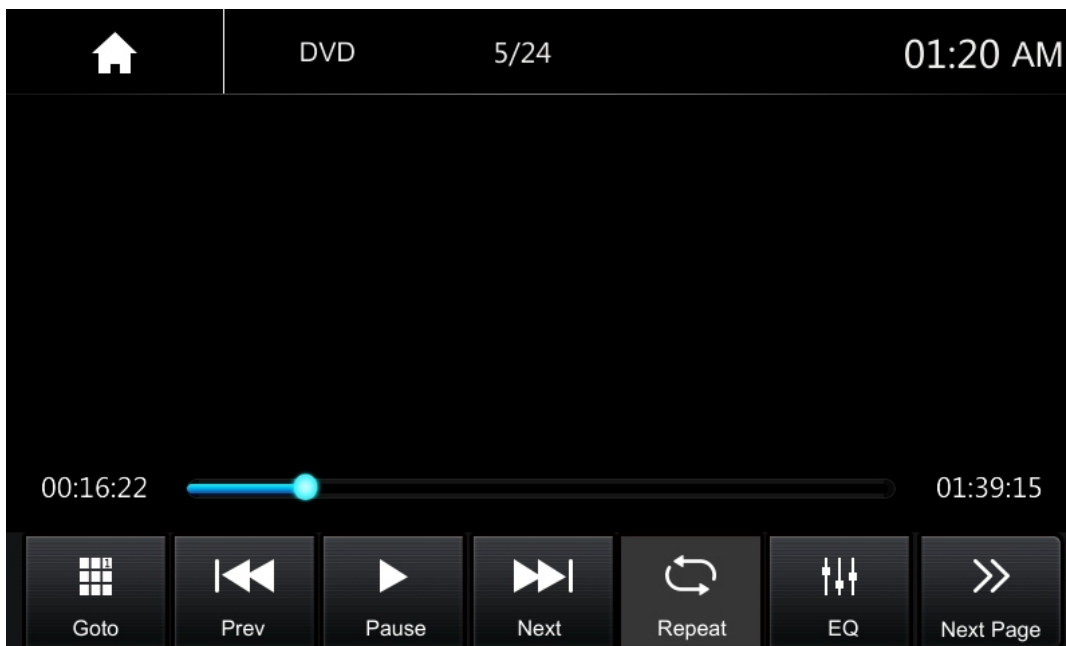

Touch it to handle gotøelecting

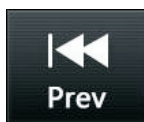

Touch it to select previous chapter

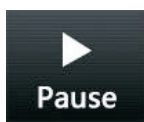

Touch it to toggle play or pause

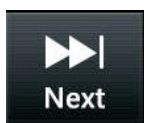

Touch it to select next chapter

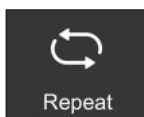

Repeat Press it to select repeat mode

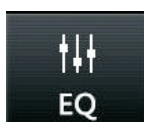

Press it to select the Audio setting or set the prefer EQ of each band in Custom mode

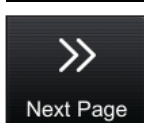

Touch it to select the second page of the keypad

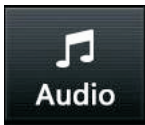

- 

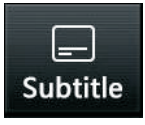
Audio Touch it to select audio language
- 

Subtitle Touch it to select subtitle language
- 

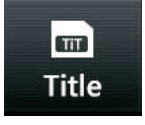
Section Touch it to select section
- 

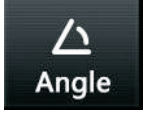
Title Touch it to show title menu
- 

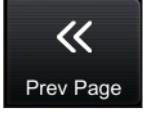
Angle Touch it to handle angle
- 

Prev Page Touch it to select the first page of the keypad

12. Bluetooth Music

Touch the **BT Music icon** to enter Bluetooth Audio playing mode. If the Bluetooth is connected, the music will be playing as following shown.

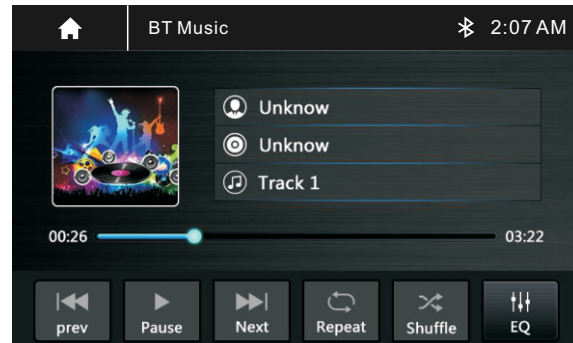

If the Bluetooth is not connected, press Reconnect to connect the paired phone or Pairing to pair the new device.

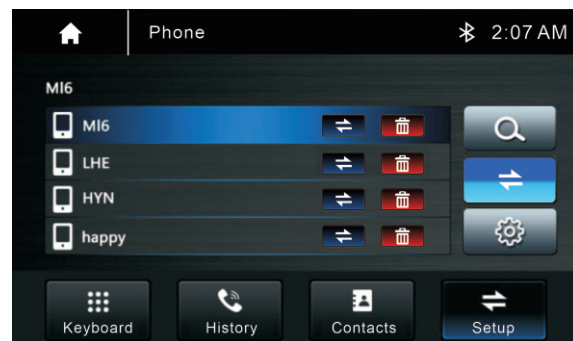
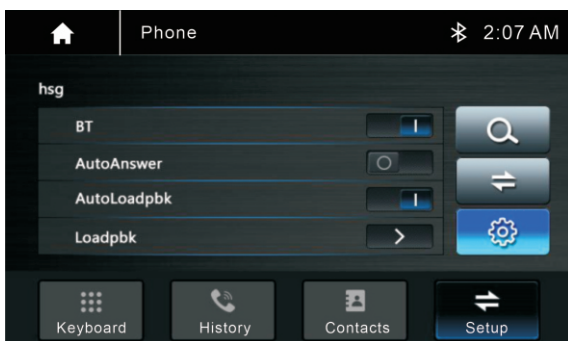

Bluetooth Pairing

Press **Pairing** the Pairing Mode screen will be shown as below:

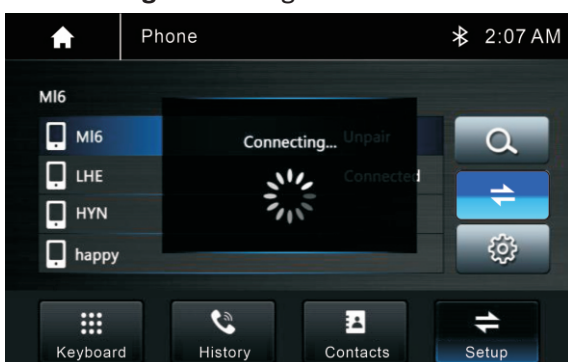

Turn On the Bluetooth of the Mobile phone / Bluetooth device, you can see the **CPAA-70D**. Select the **CPAA-70D** for pairing and connection.

Bluetooth Audio Playback

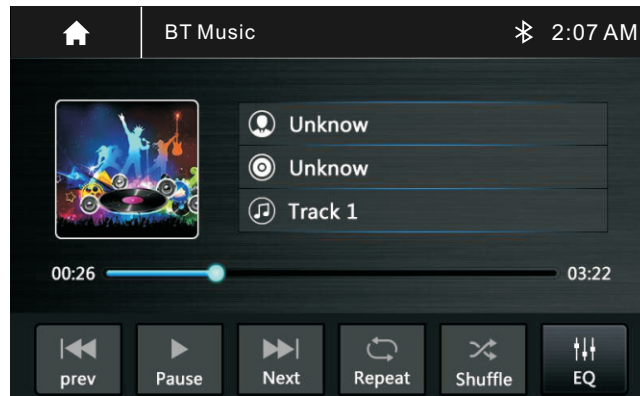

Short press it to skip to the previous track.



Play / Pause button.



Short press it to skip to the next track.



Repeat, press for select between Repeat All, Repeat One or Repeat Directory

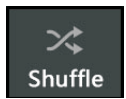

Press it to turn on/off random play.

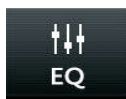

Press it to turn on/off the Audio Settings menu to adjust the EQ.

13. BT Phone

Touch the Phone icon in main menu to go to Phone mode. After the phone connected with the Head Unit via Bluetooth (HFP), user can through the Head unit to make a phone call. Please note it needs to connect the microphone for phone call.

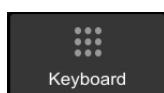
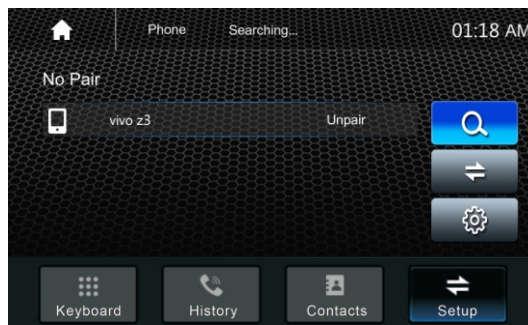

Dial Pad, tap Dial pad button to enter call mode

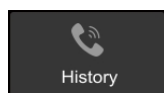

Call logs, to show the call record, missed, received and dialed calls

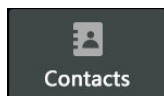

Contact, to show the phonebook connected phone

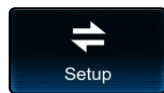

Show the usable devices



BT Setup, to set auto answer and load phonebook





Search the available device

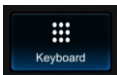

Manage the connected device

Dial a call

1. Touch the  icon and the below screen will appear.
2. Using the keyboard, touch 0-9, *,#, to enter the phone number you wish to dial. If you enter an incorrect number, touch the  icon on the keyboard to delete the incorrect number.

3. Once the correct number appears on the screen, touch the  icon. To go back dialing interface.



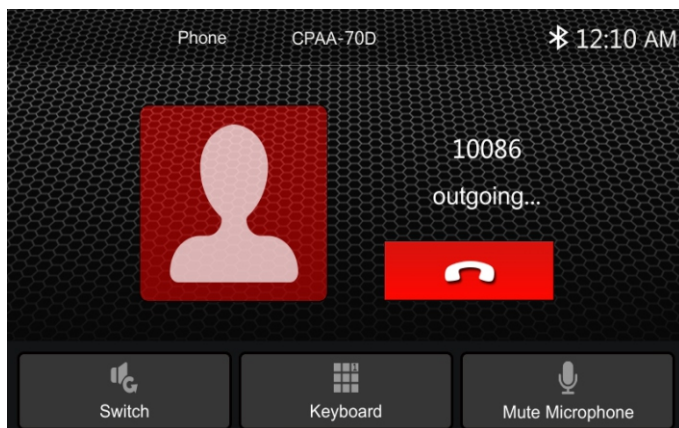

4. To end the call, touch the  icon on the screen.



Receiver an incoming call

If the Phone is connected with the unit via Bluetooth, when an incoming call, the below screen will be shown.



Press  to answer the Call or  to hang up the call.



Switch

Interchange between Phone and Headunit.



Keyboard

Display the Dial Pad.



Mute Microphone

ON/OFF the Microphone function.

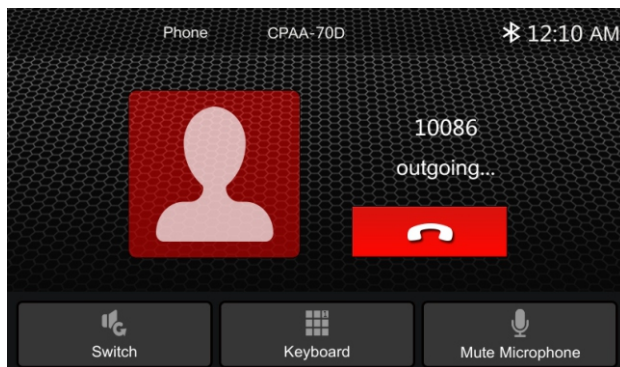

Call logs

Touch the  icon to display the Call Combined list.

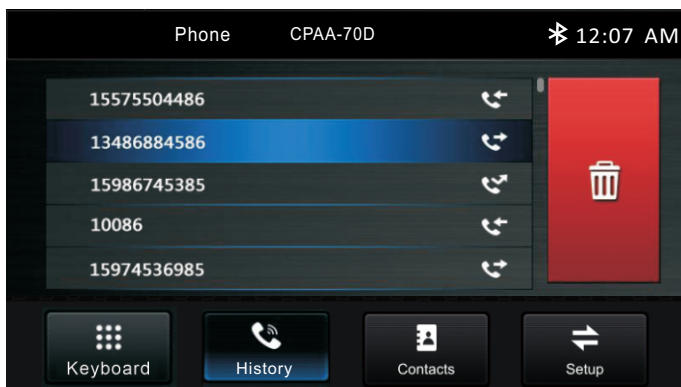

Slide the bar at right side up and down to display a Call logs up to 20 records.

Contacts

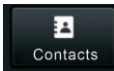
Touch the  icon to access the phone book of the connected phone. To make a call from the phone book, simply touch the contact name.



BT Setup

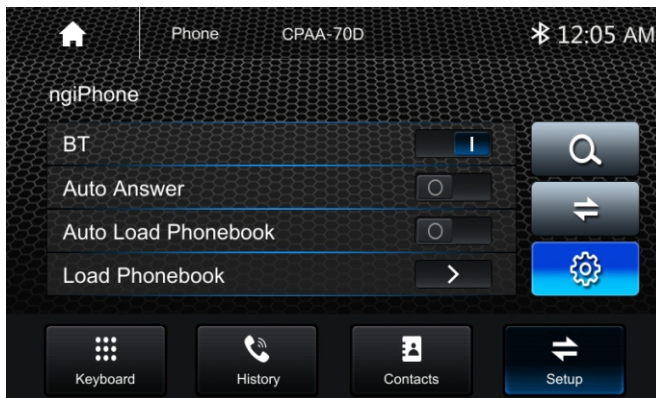

- BT On/Off , power on or off BT function
- Auto Answer On/Off, coming call auto answer
- AutoLoadpbk On/Off, when connect phone auto load phone book on or off
- Loadpbk load phone book

14. AV IN

The Audio/Video source with RCA cable can through the Head unit to play the Audio/Video. Plug the RCA to the corresponding A/V socket.

touch  to view the playing Audio/Video.

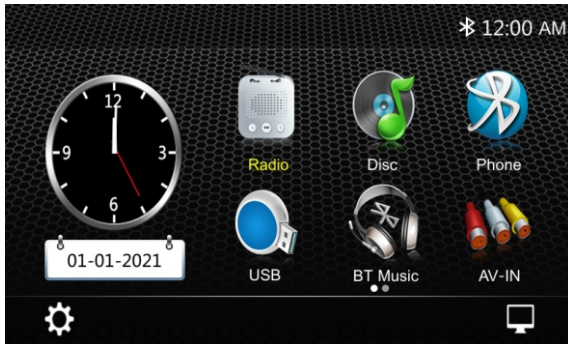

The Audio and Video will via the RCA cable to the Head unit

15. Specification

General

Power Supply	DC10~16Volts
Grounding System	Negative Ground
Current Drain	15A(Max.)
Speaker Impedance	4 ohms per channel
Frequency Response.....	20Hz~20KHz
Operating Temperature	-20~+60°C
Dimensions	175mm(W)×175mm(D)×100mm(H)

TFT Display

TFT Screen size.....	7inch
Resolution.....	1024x600 pixels

FM Radio

Frequency Range (USA)	87.5~107.9MHz
Frequency Range (Europe)	87.5~108MHz
Usable Sensitivity (S/N=30dB).....	≤ 15dB
S/N Ratio.....	≥ 55dB
Stereo Separation.....	≥ 30dB

AM/MW

Frequency Range (USA)	530~1710KHz
Frequency Range (Europe)	522~1620KHz
Usable Sensitivity(S/N=20dB).....	≤ 40dB
S/N Ratio.....	≥ 45dB

Line-Out/Subwoofer Output

Maximum Output Level (10K ohms load).....	≥ 4Vrms
Subwoofer Time Align.....	0~18ms

FCC Notes

WARNING! Changes or modifications to this unit not expressly approved by the party responsible for compliance could void the user's authority to operate the equipment.

NOTE: This equipment has been tested and found to comply with the limits for a Class B digital device, pursuant to Part 15 of the FCC Rules. These limits are designed to provide reasonable protection against harmful interference in a residential installation.

This equipment generates, uses and can radiate radio frequency energy and, if not installed and used in accordance with the instructions, may cause harmful interference to radio communications.

However, there is no guarantee that interference will not occur in a particular installation. If this equipment does cause harmful interference to radio or television reception, which can be determined by turning the equipment off and on, the user is encouraged to try to correct the interference by one or more of the following measures:

- Reorient or relocate the receiving antenna.
- Increase the separation between the equipment and receiver.
- Connect the equipment into an outlet on a circuit different from that to which the receiver is connected.
- Consult the dealer or an experienced radio/ TV technician for help.